

KRUGER P4 F0

LED-6L51E700ZKN10/F04B/L100 B DALI 3K##

WWW.OSMONT.CZ

KRUGER P4 FO

Product code: KRU50034

Type: LED-6L51E700ZKN10/FO4B/L100 B DALI 3K##

Short description of the luminaire: White colour | pendant LED light DALI | opal plastic shade| decorative collar | rod pendant 100 cm |

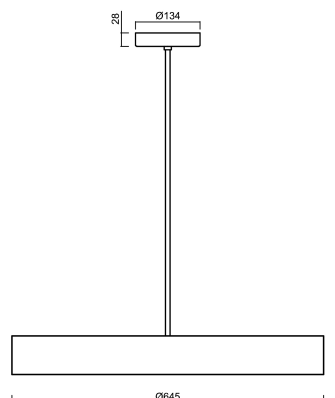
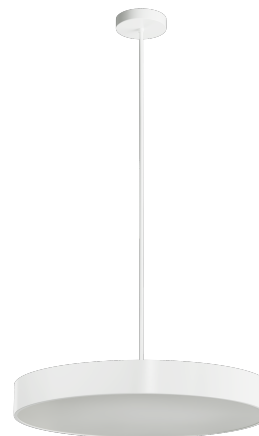

Technical data

Types of luminaires	Dimmable
Mounting type	Suspended - rod
Base material	steel
Shade material	Plastic opal (FO) with metal collar
Base color	white Ral9003
Shade color	white
Holding the shade	folding system
Mounting location	ceiling
Width	645 mm
Length	645 mm
Height	80 mm
Diameter	Ø 645 mm
Suspension length	1000 mm
mounting holes (diameter)	2xØ5mm
Cable entrance	2xØ16mm
Energy Class	D
Operating temperature	from -20°C to +30°C

Electrical data

Power consumption	65 W
Ingress Protection	IP40
Socket	LED modul
terminal block	screw terminal block
Automatic circuit breaker type B10A	11 pcs
Automatic circuit breaker type B16A	18 pcs
Automatic circuit breaker type C10A	19 pcs
Automatic circuit breaker type C16A	31 pcs
Number of LED drivers	2

Luminous data

Lum. flux of luminaire	8310 lm
Lum. flux of light source	10520 lm
Luminaire efficacy	127 lm/W
Chromaticity temperature	3000 K
Rated life time LED L80/B10	100000 hours
CRI	Ra80
MacAdam	3
Blue light hazard	Risk group 0

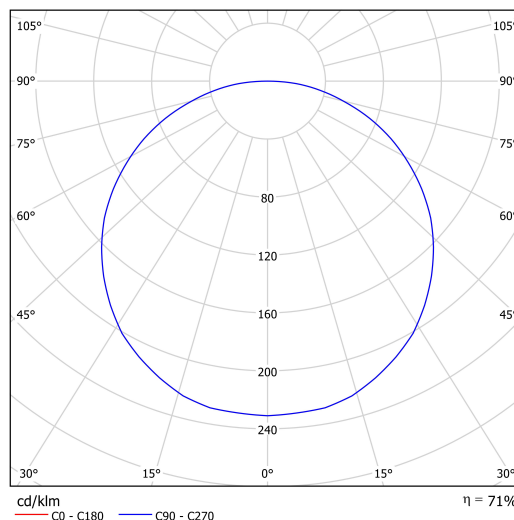

Eulum data for calculation programs are available at

OSMONT, s.r.o.
HYBRÁLEC 129,
586 01 JIHLAVA, CZ

Logistical data

EAN	8591728229450
Warranty*	60 months

*The warranty for the batteries is valid for 36 months from the date of purchase.

Installation dimensions:

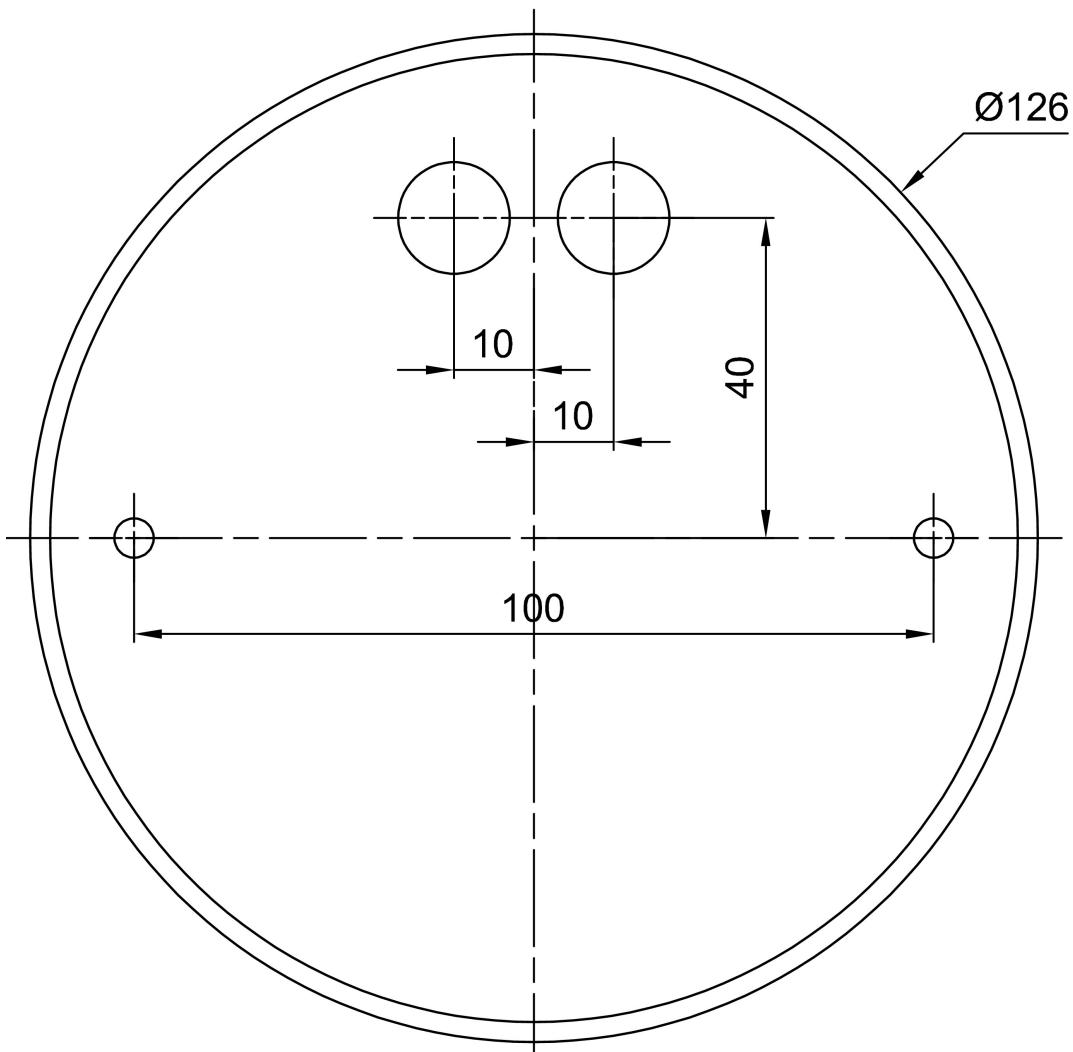

Additional assortment:

Lampshade

Product code	Name	Color	Picture	Drawing
20728	F04B	white		