

KRUGER P3 FOP

LED-1L20E700ZKN94/FOP3C/z5 C DALI 4K#

WWW.OSMONT.CZ

KRUGER P3 FOP

Product code: KRU60725

Type: LED-1L20E700ZKN94/FOP3C/z5 C DALI 4K#

Short description of the luminaire: Black color | pendant LED light | dimmable DALI | opal prismatic shade | decorative collar

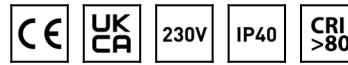

Technical

| | |
|------------------------------|--|
| Types of luminaires | Dimmable |
| Mounting type | Suspended - rod |
| Base material | steel |
| Shade material | Plastic opal prismatic (FOP) with metal collar |
| Base color | black Ral9005 |
| Shade color | white - black |
| Holding the shade | folding system |
| Mounting location | ceiling |
| Width | 490 mm |
| Length | 490 mm |
| Height | 80 mm |
| Diameter | ø 490 mm |
| Hinge length | 1000 mm |
| mounting holes (diameter) | 2xø5mm |
| Installation wire (diameter) | 2xø16mm |
| Energy Class | D |
| Operating temperature | from -20°C to +30°C |

Electric

| | |
|-------------------------------------|----------------------|
| Power consumption | 32 W |
| Ingress Protection | IP40 |
| Socket | LED modul |
| terminal block | screw terminal block |
| Automatic circuit breaker type B10A | 18 pcs |
| Automatic circuit breaker type B16A | 28 pcs |
| Automatic circuit breaker type C10A | 30 pcs |
| Automatic circuit breaker type C16A | 46 pcs |

Luminous

| | |
|-----------------------------|--------------|
| Lum. flux of luminaire | 3000 lm |
| Lum. flux of light source | 5560 lm |
| Luminaire efficacy | 93 lm/W |
| Temperature | 4000 K |
| Rated life time LED L80/B10 | 100000 hours |
| CRI | Ra80 |
| MacAdam | 3 |
| Blue light hazard | Risk group 0 |

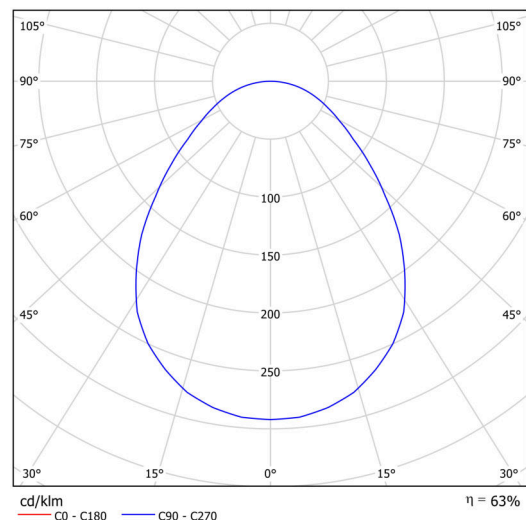
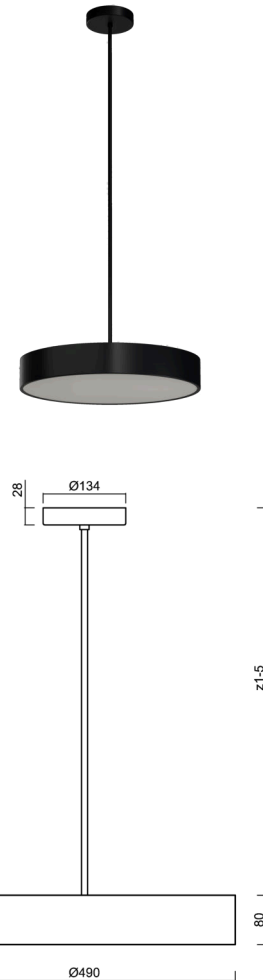

Eulum data for calculation programs are available at www.osmont.cz.

TECHNICAL SHEET



Logistic

| | |
|-----------|---------------|
| EAN | 8591728085261 |
| Warranty* | 60 months |

*The warranty for the batteries is valid for 12 months from the date of purchase.

Installation dimensions:

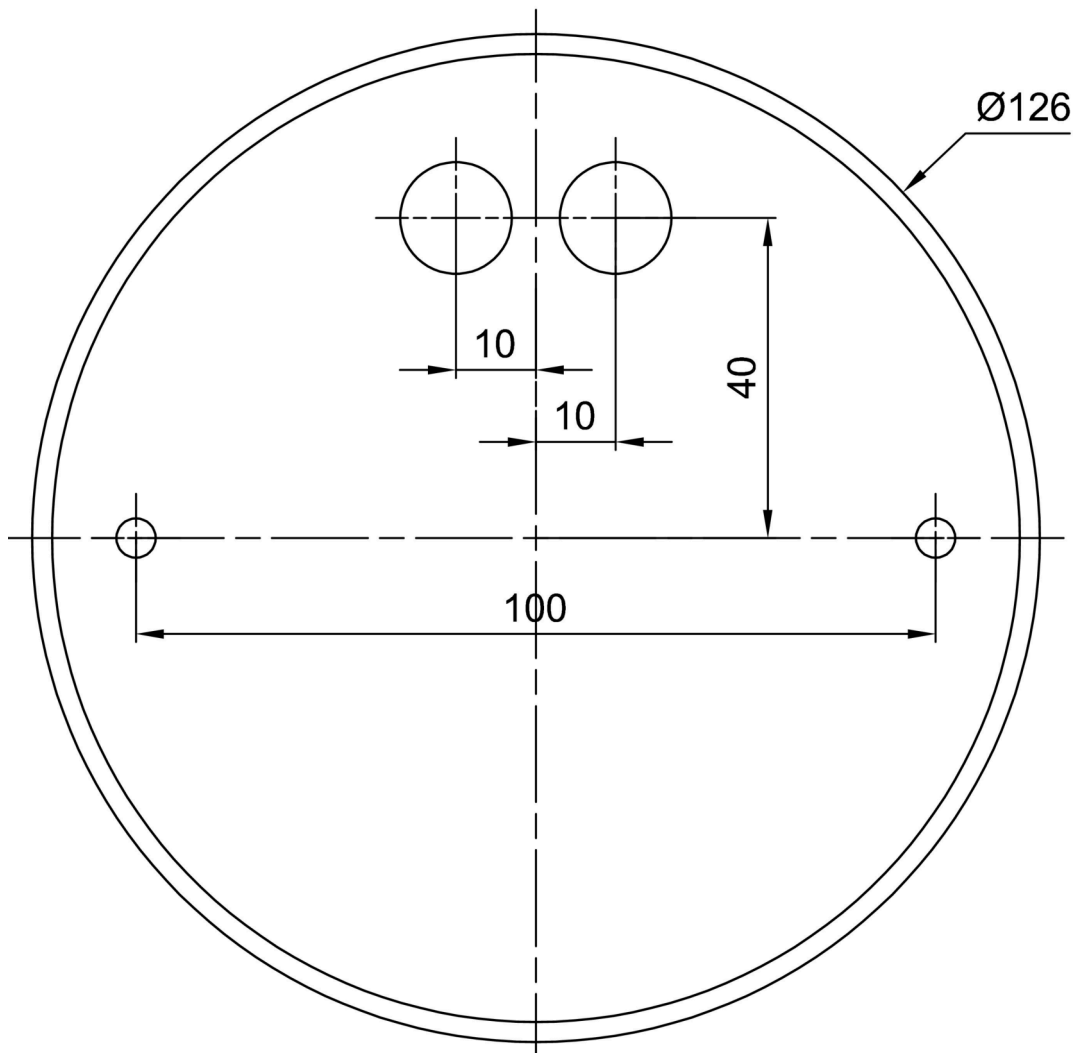

Additional assortment:

Lampshade

| Product code | Name | Color | Description | Picture | Drawing |
|--------------|-------|---------------|-------------|--|---------|
| 20647 | FOP3C | white - black | |  | |