

KRUGER P2 FOP

LED-1L16EMP700ZKN83/FOP2C/z5/NK1W C 4K#

WWW.OSMONT.CZ

KRUGER P2 FOP

Product code: KRU60701

Type: LED-1L16EMP700ZKN83/FOP2C/z5/NK1W C 4K#

Short description of the luminaire: Black color | pendant LED light | emergency combi unit | multipower function | opal prismatic shade | decorative collar

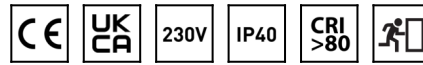

Technical

Types of luminaires	Emergency combined
Mounting type	Suspended - rod
Base material	steel
Shade material	Plastic opal prismatic (FOP) with metal collar
Base color	black Ral9005
Shade color	white - black
Holding the shade	folding system
Mounting location	ceiling
Width	395 mm
Length	395 mm
Height	80 mm
Diameter	Ø 395 mm
Hinge length	1000 mm
mounting holes (diameter)	2xØ5mm
Installation wire (diameter)	2xØ16mm
Energy Class	D
Operating temperature	from 0°C to +30°C

Electric

Power consumption	34 W
Ingress Protection	IP40
Socket	LED modul
Battery type	NiCd
Emergency time	3 hours
terminal block	screw terminal block
Automatic circuit breaker type B10A	26 pcs
Automatic circuit breaker type B16A	40 pcs
Automatic circuit breaker type C10A	30 pcs
Automatic circuit breaker type C16A	48 pcs

Luminous

Lum. flux of luminaire	2850 lm
Lum. flux of light source	5270 lm
Luminaire efficacy	83 lm/W
Temperature	4000 K
Rated life time LED L80/B10	100000 hours
CRI	Ra80
MacAdam	3
Blue light hazard	Risk group 0

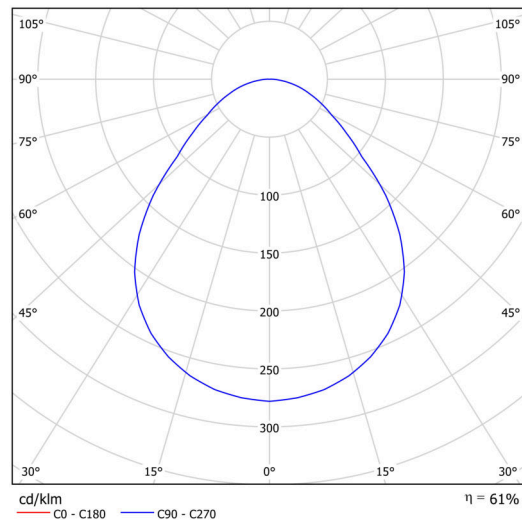
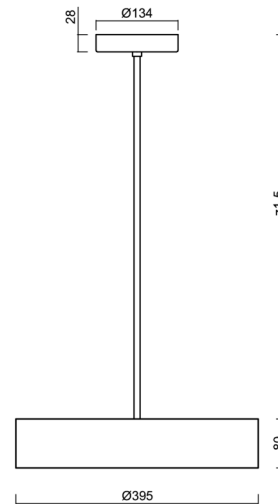
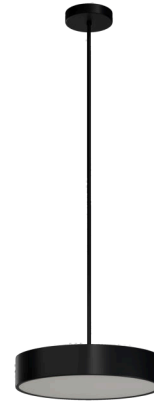

TECHNICAL SHEET



Eulum data for calculation programs are available at www.osmont.cz.

Multipower

Possibility of output adjustment by the user (DIP switch on the current source).

I [mA]	700	600	500	400	
[%]	100	86	71	57	

Logistic

EAN	8591728085025
Warranty*	60 months

*The warranty for the batteries is valid for 12 months from the date of purchase.

Installation dimensions:

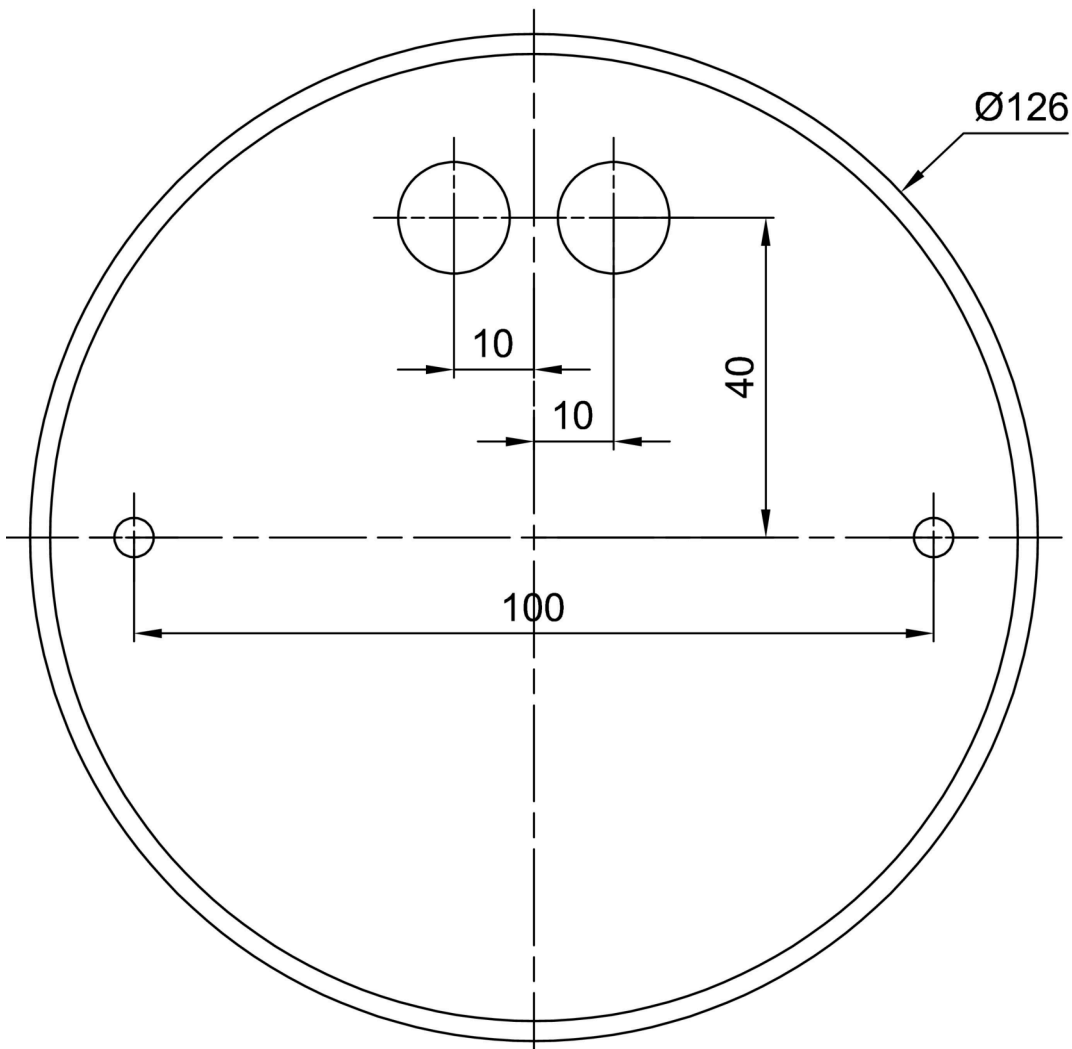

Additional assortment:

Lampshade

Product code	Name	Color	Description	Picture	Drawing
20641	FOP2C	white - black		