

KRUGER P2 F0

LED-1L16E500ZKN83/F02B/z5 NK3HST B 4K#

WWW.OSMONT.CZ

KRUGER P2 FO

Product code: KRU60780

Type: LED-1L16E500ZKN83/F02B/z5 NK3HST B 4K#

Short description of the luminaire: White colour | pendant LED light with emergency backup combined (with Self-test) | opal plastic shade| decorative collar | rod pendant 100 cm |



Technical

Types of luminaires	Emergency combined SELFTEST
Mounting type	Suspended - rod
Base material	steel
Shade material	Plastic opal (FO) with metal collar
Base color	white Ra19003
Shade color	white
Holding the shade	folding system
Mounting location	ceiling
Width	395 mm
Length	395 mm
Height	80 mm
mounting holes (diameter)	2xØ5mm
Cable entrance	2xØ16mm
Energy Class	D
Impact strength	IKxx
Operating temperature	from -20°C to +30°C

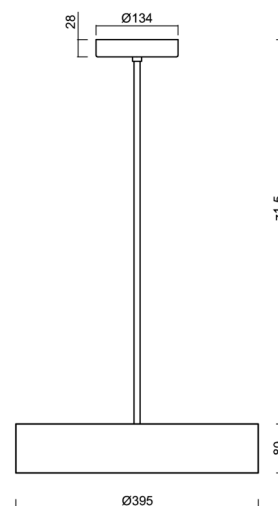
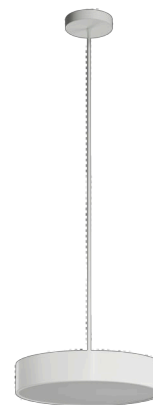

Electric

Power consumption	24 W
Ingress Protection	IP40
Socket	LED modul
Battery type	LiFePO4
Emergency time	3 hours
SELFTEST	yes
terminal block	screw terminal block

Luminous

Lum. flux of luminaire	2780 lm
Lum. flux of light source	3910 lm
Lum. flux of light source in emergency mode	200 lm
Temperature	4000 K
Rated life time LED L80/B10	100000 hours
CRI	Ra80
MacAdam	3
Blue light hazard	Risk group 0

Eulum data for calculation programs are available at www.osmont.cz.

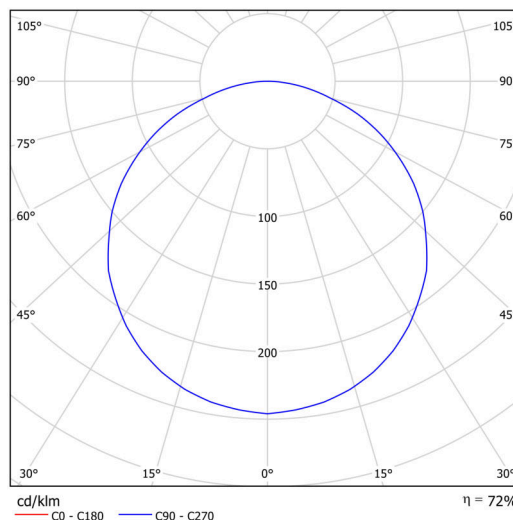

TECHNICAL SHEET



Logistic

EAN	8591728158385
Number of cartons	1 pcs
Warranty*	60 months

*The warranty for the batteries is valid for 12 months from the date of purchase.

Installation dimensions:

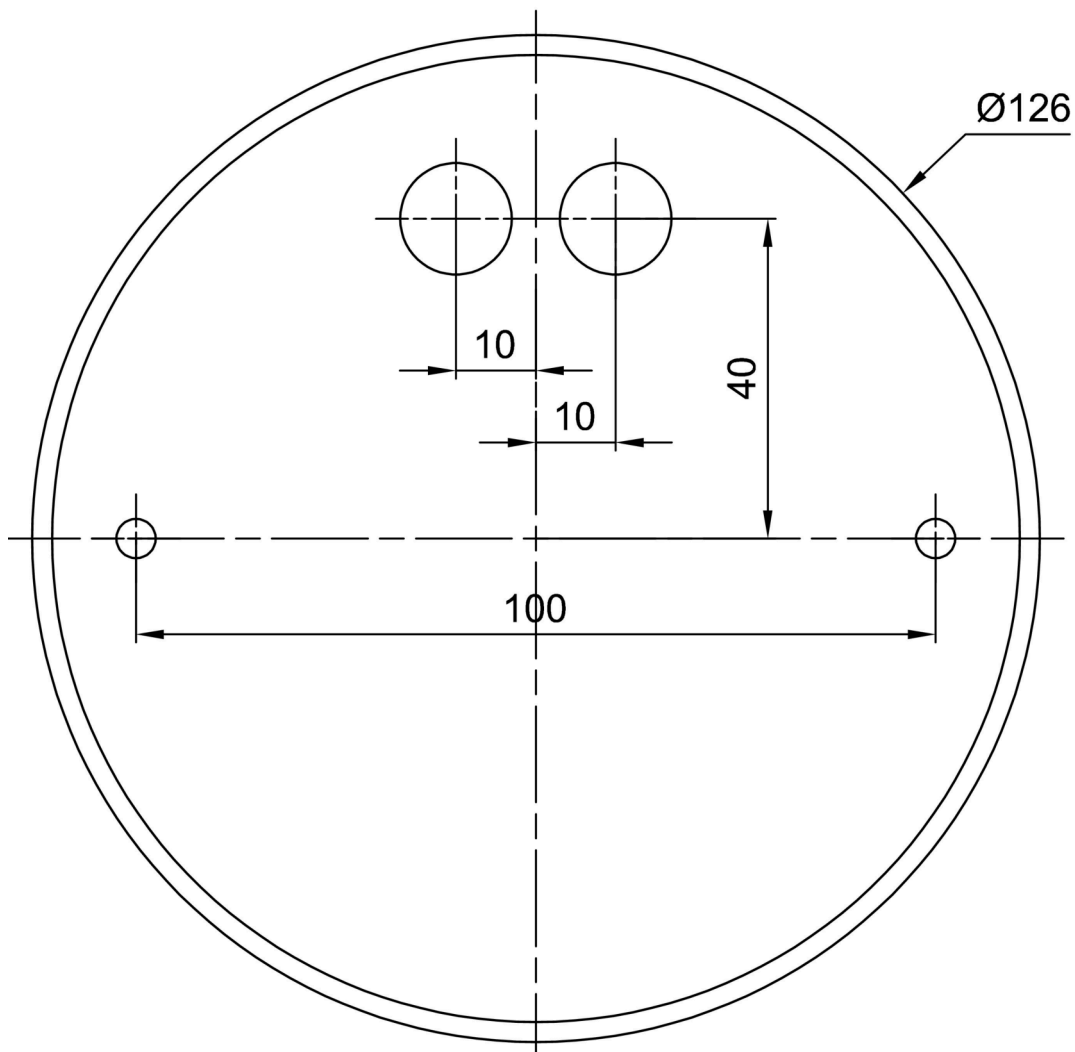

Additional assortment:

Lampshade

Product code	Name	Color	Description	Picture	Drawing
20637	F02B	white	příslušenství	