



## KRUGER P1 FC

LED-1L14EMP700ZKN62/FC1B/z5 B 4K#

[WWW.OSMONT.CZ](http://WWW.OSMONT.CZ)

# KRUGER P1 FC

Product code: KRU60660

Type: LED-1L14EMP700ZKN62/FC1B/z5 B 4K#

Short description of the luminaire: White color | pendant LED light | ON/OFF | multipower function | design black shade | decorative collar



## Technical

Types of luminaires	Classic on/off
Mounting type	Suspended - rod
Base material	steel
Shade material	Black plastic with metal collar
Base color	white Ral9003
Shade color	white - black
Holding the shade	folding system
Mounting location	ceiling
Width	300 mm
Length	300 mm
Height	80 mm
Diameter	ø 300 mm
Hinge length	1000 mm
mounting holes (diameter)	3xø5mm
Installation wire (diameter)	2xø16mm
Energy Class	D
Operating temperature	from -20°C to +30°C

## Electric

Power consumption	18 W
Ingress Protection	IP40
Socket	LED modul
terminal block	snap terminal block
Automatic circuit breaker type B10A	37 pcs
Automatic circuit breaker type B16A	59 pcs
Automatic circuit breaker type C10A	37 pcs
Automatic circuit breaker type C16A	59 pcs

## Luminous

Lum. flux of luminaire	340 lm
Lum. flux of light source	2810 lm
Luminaire efficacy	18 lm/W
Temperature	4000 K
Rated life time LED L80/B10	100000 hours
CRI	Ra80
MacAdam	3
Blue light hazard	Risk group 0

Eulum data for calculation programs are available at [www.osmont.cz](http://www.osmont.cz).

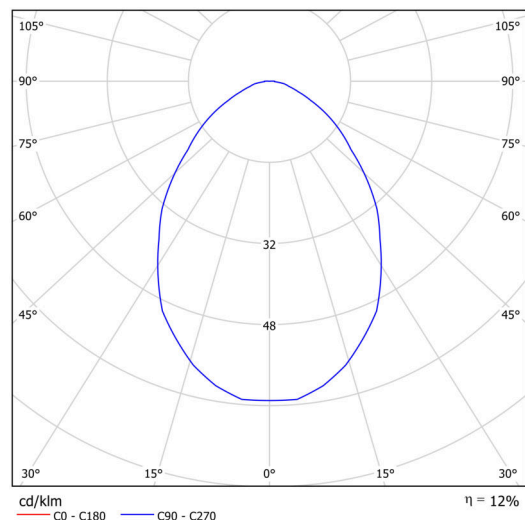
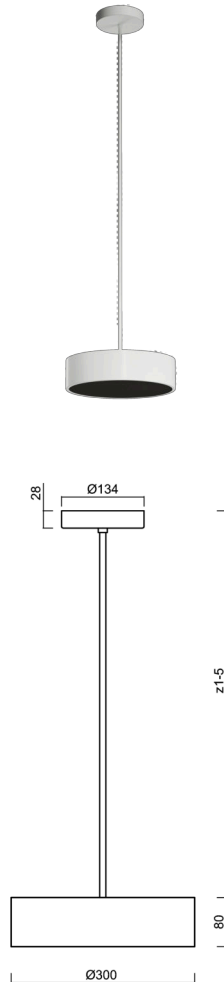

# TECHNICAL SHEET



## Multipower

Possibility of output adjustment by the user (DIP switch on the current source).

I [mA]	700	600	500	400	
[%]	100	86	71	57	

## Logistic

EAN	8591728084615
Weight NTTO	2.8 Kg
Weight BTTO	3.6 Kg
Warranty*	60 months

\*The warranty for the batteries is valid for 12 months from the date of purchase.

## Installation dimensions:

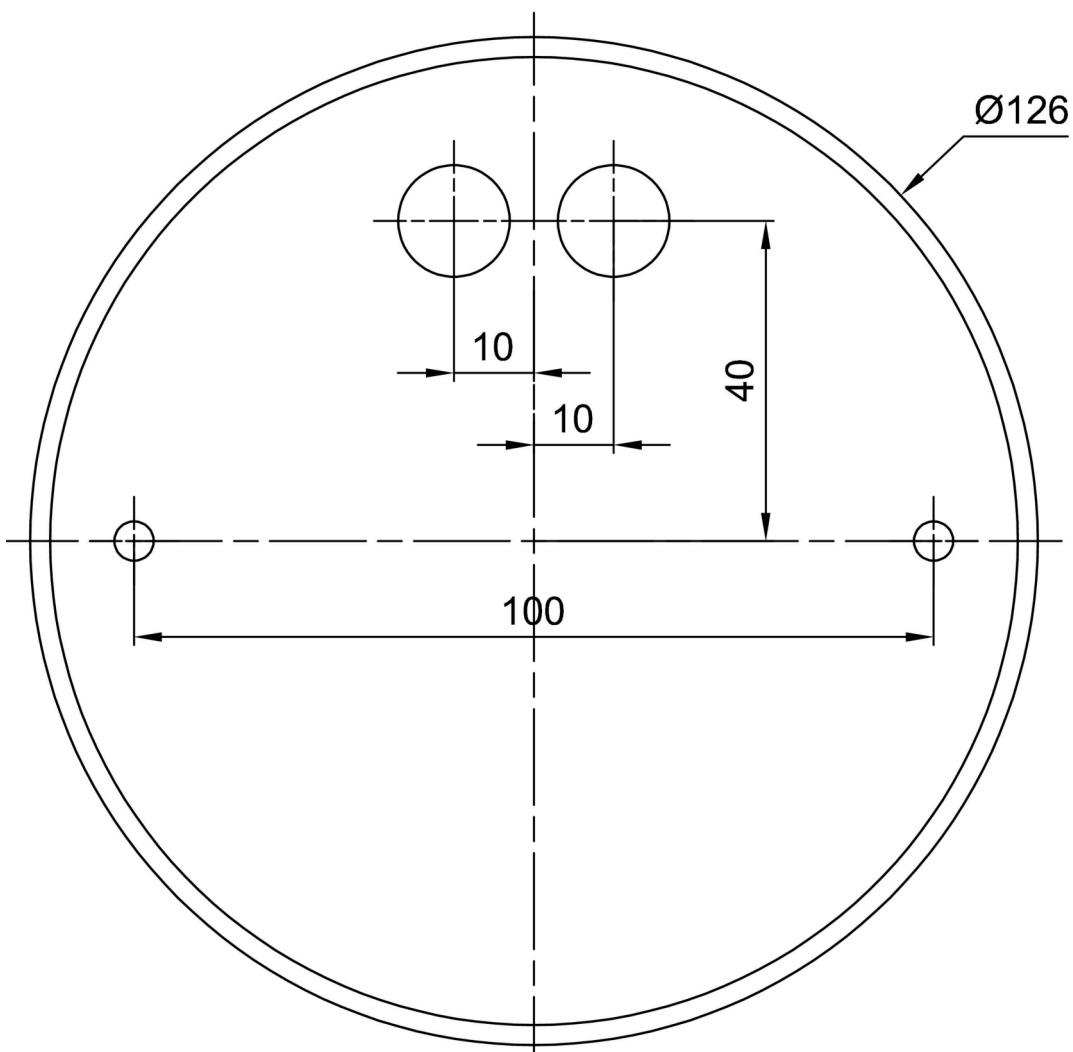

## Additional assortment:

## Lampshade

Product code	Name	Color	Description	Picture	Drawing
20633	FC1B	white - black		