



KRUGER 3 FOP

LED-1L20ET1050KN94/FOP3B BT 27-65K#

WWW.OSMONT.CZ

KRUGER 3 FOP

Product code: KRU61019

Type: LED-1L20ET1050KN94/FOP3B BT 27-65K#

Short description of the luminaire: White color | surface-mounted LED light | Bluetooth Tunable White system | opal prismatic shade | decorative collar

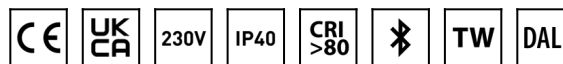

Technical

| | |
|------------------------------|------------------------------------------------|
| Types of luminaires | Tunable White |
| Mounting type | surface mounted |
| Base material | steel |
| Shade material | Plastic opal prismatic (FOP) with metal collar |
| Base color | white Ral9003 |
| Shade color | white |
| Holding the shade | folding system |
| Mounting location | ceiling/wall |
| Width | 490 mm |
| Length | 490 mm |
| Height | 80 mm |
| Diameter | ø 490 mm |
| mounting holes (diameter) | 3xø5mm |
| Installation wire (diameter) | 2xø16mm |
| Energy Class | D |
| Operating temperature | from -20°C to +30°C |

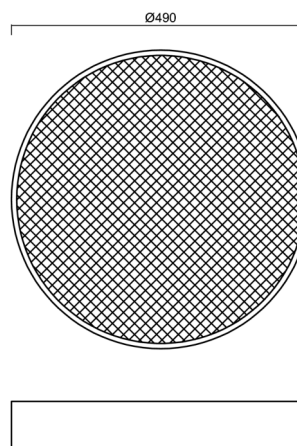

Electric

| | |
|-------------------------------------|---------------------|
| Power consumption | 48 W |
| Ingress Protection | IP40 |
| Socket | LED modul |
| terminal block | snap terminal block |
| Automatic circuit breaker type B10A | 14 pcs |
| Automatic circuit breaker type B16A | 23 pcs |

Luminous

| | |
|-----------------------------|--------------|
| Lum. flux of luminaire | 4750 lm |
| Lum. flux of light source | 7790 lm |
| Luminaire efficacy | 98 lm/W |
| Temperature | 2700-6500 K |
| Rated life time LED L80/B10 | 100000 hours |
| CRI | Ra80 |
| MacAdam | 3 |
| Blue light hazard | Risk group 0 |

Eulum data for calculation programs are available at www.osmont.cz.

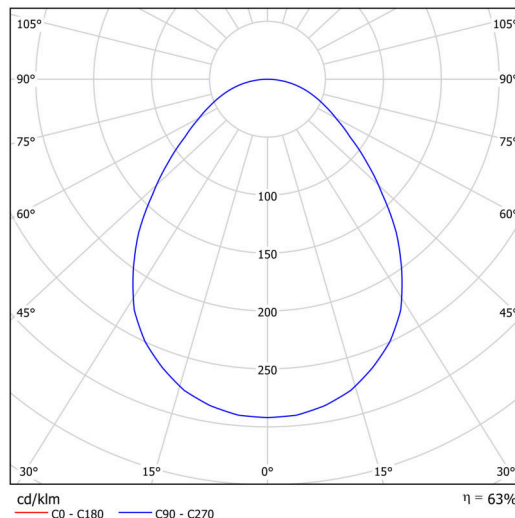

TECHNICAL SHEET



Logistic

| | |
|-------------|---------------|
| EAN | 8591728085520 |
| Weight NTTO | 3.76 Kg |
| Weight BTTO | 4.16 Kg |
| Warranty* | 60 months |

*The warranty for the batteries is valid for 12 months from the date of purchase.

Installation dimensions:

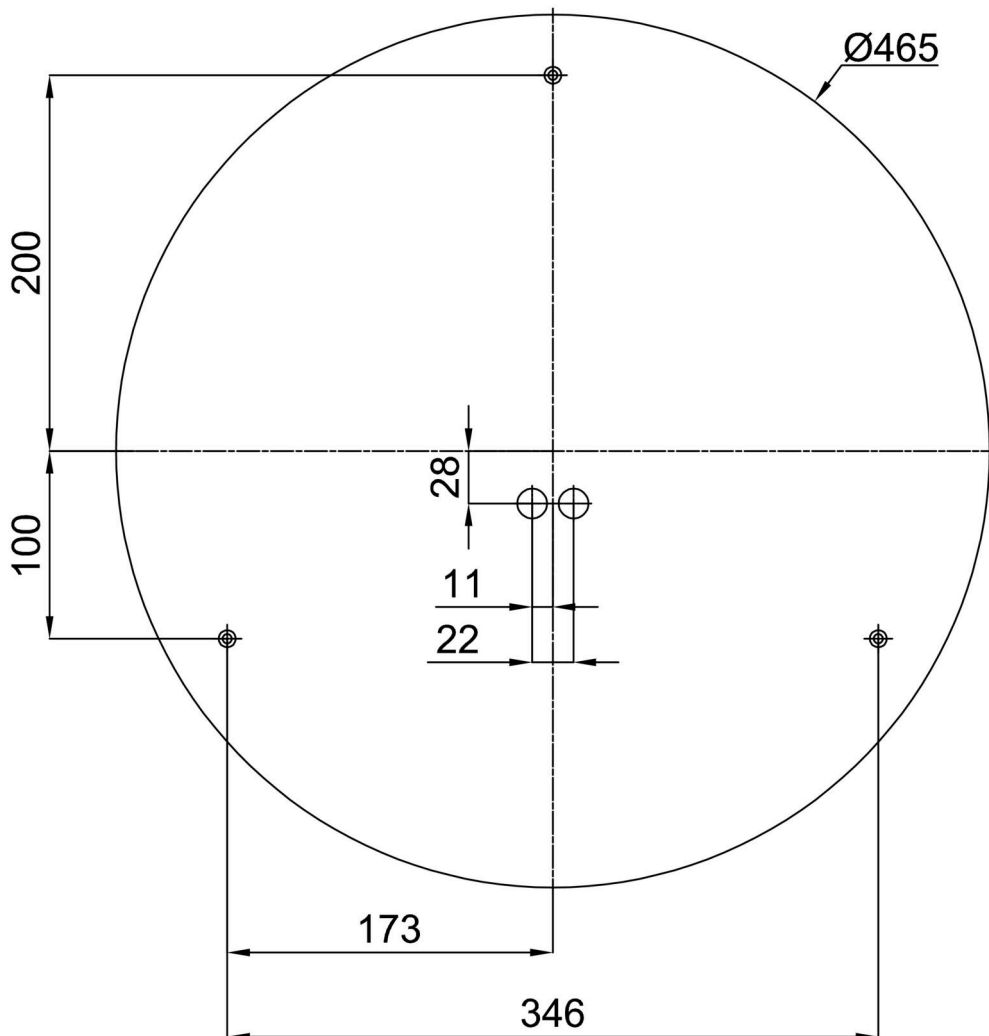

Additional assortment:

Base for surface mounting

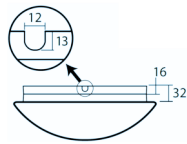
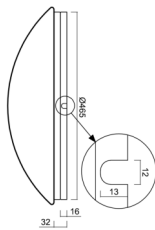
| Product code | Name | Color | Description | Picture | Drawing |
|--------------|----------------|------------------|-------------|------------------------------------------------------------------------------------|-------------------------------------------------------------------------------------|
| 33503 | KN9,K9,B17 /BP | white Ral9003 | |  |  |

Lampshade

| Product code | Name | Color | Description | Picture | Drawing |
|--------------|-------|-------|-------------|------------------------------------------------------------------------------------|---------|
| 20644 | FOP3B | white | |  | |