



KRUGER 3 FOP

LED-1L20EMP700KN94/FOP3B/NK1W 3K#

WWW.OSMONT.CZ

KRUGER 3 FOP

Product code: KRU60118

Type: LED-1L20EMP700KN94/FOP3B/NK1W 3K#

Short description of the luminaire: White color | surface-mounted LED light | emergency combi unit | multipower function | opal prismatic shade | decorative collar



Technical

Types of luminaires	Emergency combined
Mounting type	surface mounted
Base material	steel
Shade material	Plastic opal prismatic (FOP) with metal collar
Base color	white Ral9003
Shade color	white
Holding the shade	folding system
Mounting location	ceiling/wall
Width	490 mm
Length	490 mm
Height	80 mm
Diameter	ø 490 mm
mounting holes (diameter)	3xø5mm
Installation wire (diameter)	2xø16mm
Energy Class	D
Operating temperature	from 0°C to +30°C

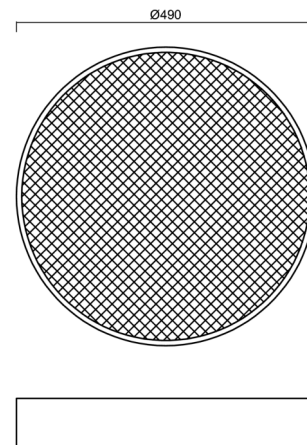

Electric

Power consumption	32 W
Ingress Protection	IP40
Socket	LED modul
Battery type	NiCd
Emergency time	3 hours
terminal block	snap terminal block
Automatic circuit breaker type B10A	26 pcs
Automatic circuit breaker type B16A	40 pcs
Automatic circuit breaker type C10A	30 pcs
Automatic circuit breaker type C16A	48 pcs

Luminous

Lum. flux of luminaire	3250 lm
Lum. flux of light source	5330 lm
Luminaire efficacy	101 lm/W
Temperature	3000 K
Rated life time LED L80/B10	100000 hours
CRI	Ra80
MacAdam	3
Blue light hazard	Risk group 0

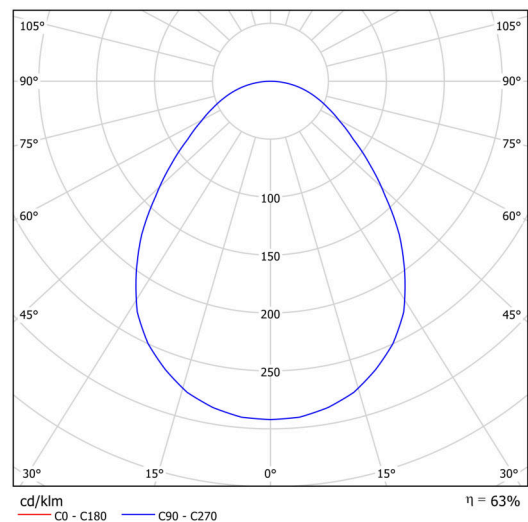

Eulum data for calculation programs are available at

Multipower

Possibility of output adjustment by the user (DIP switch on the current source).

I [mA]	700	600	500	400	
[%]	100	86	71	57	

Logistic

EAN	8591728081874
Weight NTTO	3.76 Kg
Weight BTTO	4.16 Kg
Warranty*	60 months

*The warranty for the batteries is valid for 12 months from the date of purchase.

Installation dimensions:

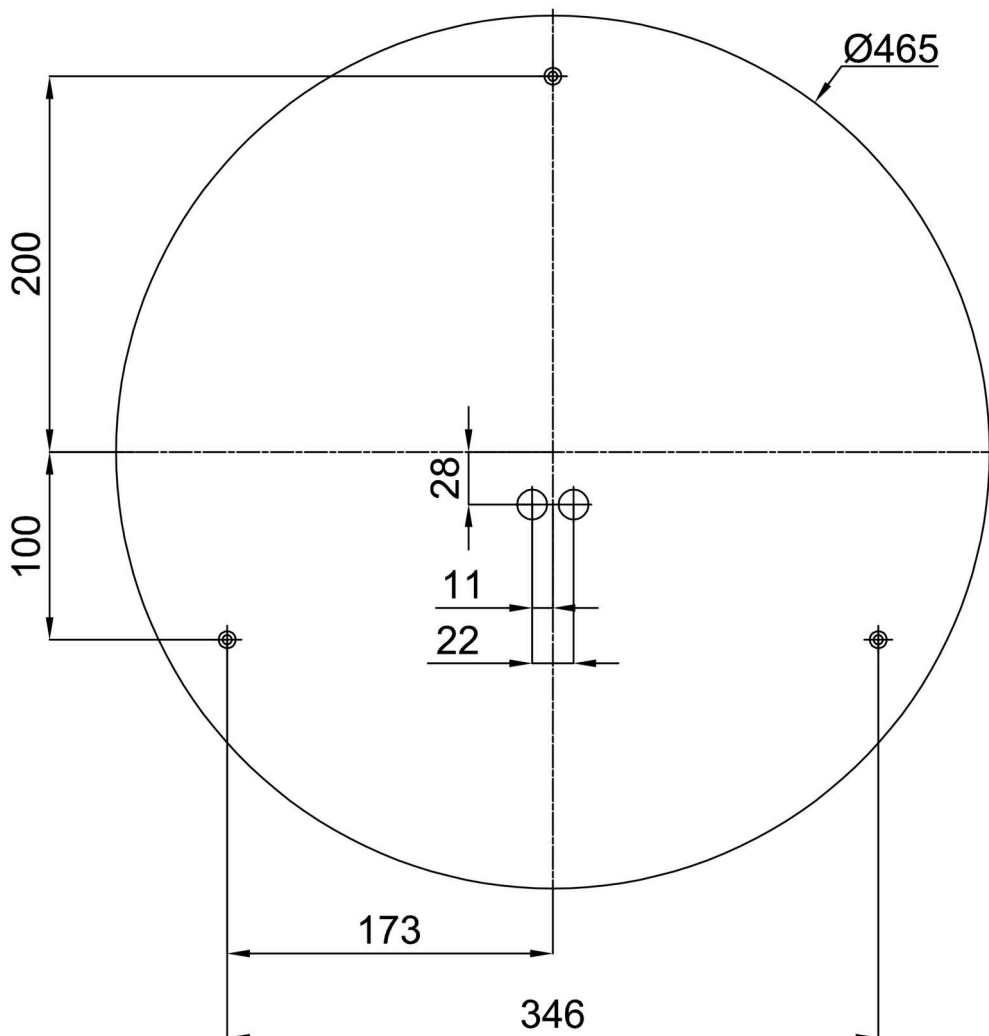

Additional assortment:

Base for surface mounting

Product code	Name	Color	Description	Picture	Drawing
33503	KN9,K9,B17 /BP	white Ral9003			

Lampshade

Product code	Name	Color	Description	Picture	Drawing
20644	FOP3B	white		