



## **KRUGER 2 F0**

---

LED-1L16ET700KN83/F02B BT 27-65K#

[WWW.OSMONT.CZ](http://WWW.OSMONT.CZ)

# KRUGER 2 FO

Product code: KRU61009

Type: LED-1L16ET700KN83/FO2B BT 27-65K#

Short description of the luminaire: White color | surface-mounted LED light | Bluetooth Tunable White system | opal plastic shade | decorative collar

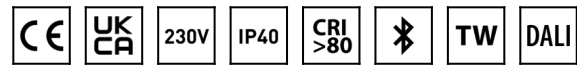

## Technical

Types of luminaires	Tunable White
Mounting type	surface mounted
Base material	steel
Shade material	Plastic opal (FO) with metal collar
Base color	white Ral9003
Shade color	white
Holding the shade	folding system
Mounting location	ceiling/wall
Width	395 mm
Length	395 mm
Height	80 mm
Diameter	ø 395 mm
mounting holes (diameter)	3xø5mm
Installation wire (diameter)	2xø16mm
Energy Class	D
Operating temperature	from -20°C to +30°C

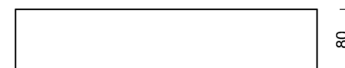
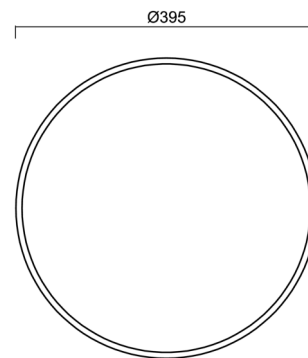

## Electric

Power consumption	33 W
Ingress Protection	IP40
Socket	LED modul
terminal block	snap terminal block
Automatic circuit breaker type B10A	22 pcs
Automatic circuit breaker type B16A	36 pcs

## Luminous

Lum. flux of luminaire	3610 lm
Lum. flux of light source	5090 lm
Luminaire efficacy	109 lm/W
Temperature	2700-6500 K
Rated life time LED L80/B10	100000 hours
CRI	Ra80
MacAdam	3
Blue light hazard	Risk group 0

Eulum data for calculation programs are available at [www.osmont.cz](http://www.osmont.cz).

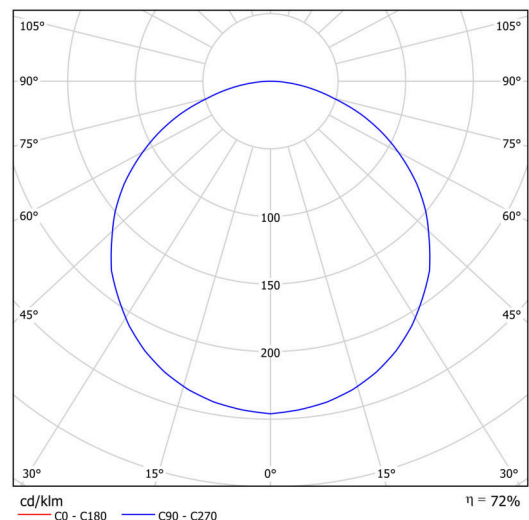

Logistic

EAN	8591728085421
Weight NTTO	2.7 Kg
Weight BTTO	3.1 Kg
Warranty*	60 months

\*The warranty for the batteries is valid for 12 months from the date of purchase.

Installation dimensions:

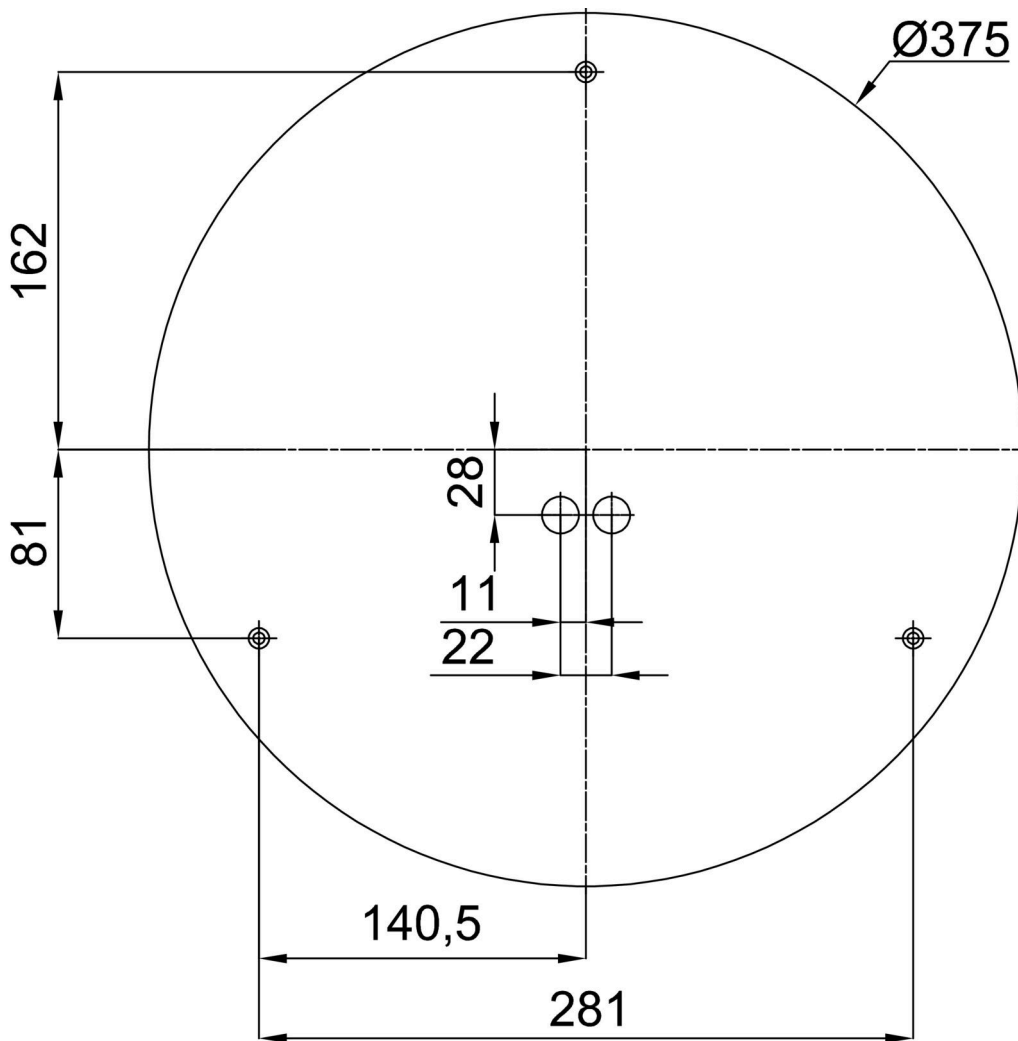

Additional assortment:

Base for surface mounting

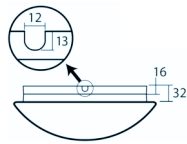
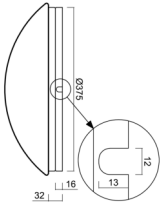
Product code	Name	Color	Description	Picture	Drawing
33502	KN8,K8/BP	white Ra19003			

Lampshade

Product code	Name	Color	Description	Picture	Drawing
20637	F02B	white		