



KRUGER 1 FOP

LED-1L14E500KN63/FOP1C HF 4K#

WWW.OSMONT.CZ

KRUGER 1 FOP

Product code: KRU60539

Type: LED-1L14E500KN63/FOP1C HF 4K#

Short description of the luminaire: Black color | surface-mounted LED light | microwave HF sensor | opal prismatic shade | decorative collar



Technical

Types of luminaires	Sensor
Mounting type	surface mounted
Base material	steel
Shade material	Plastic opal prismatic (FOP) with metal collar
Base color	black Ral9005
Shade color	white - black
Holding the shade	folding system
Mounting location	ceiling/wall
Width	300 mm
Length	300 mm
Height	80 mm
Diameter	ø 300 mm
mounting holes (diameter)	3xø5mm
Installation wire (diameter)	2xø16mm
Energy Class	D
Operating temperature	from -20°C to +30°C

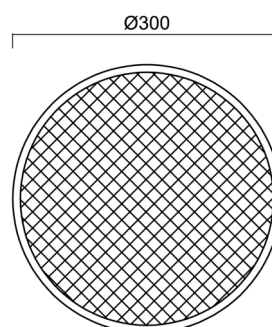

Electric

Power consumption	13 W
Ingress Protection	IP40
Socket	LED modul
Sensor	HF
terminal block	snap terminal block
Automatic circuit breaker type B10A	37 pcs
Automatic circuit breaker type B16A	59 pcs
Automatic circuit breaker type C10A	37 pcs
Automatic circuit breaker type C16A	59 pcs

Luminous

Lum. flux of luminaire	1120 lm
Lum. flux of light source	2080 lm
Luminaire efficacy	86 lm/W
Temperature	4000 K
Rated life time LED L80/B10	100000 hours
CRI	Ra80
MacAdam	3
Blue light hazard	Risk group 0

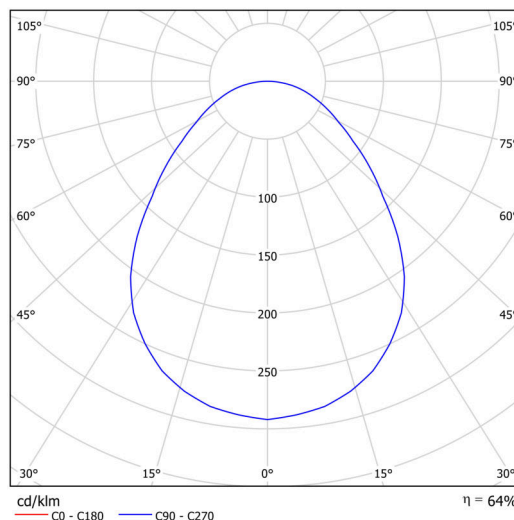

Eulum data for calculation programs are available at www.osmont.cz.

Logistic

EAN	8591728083403
Weight NTTO	1.6 Kg
Weight BTTO	1.9 Kg
Warranty*	60 months

*The warranty for the batteries is valid for 12 months from the date of purchase.

Installation dimensions:

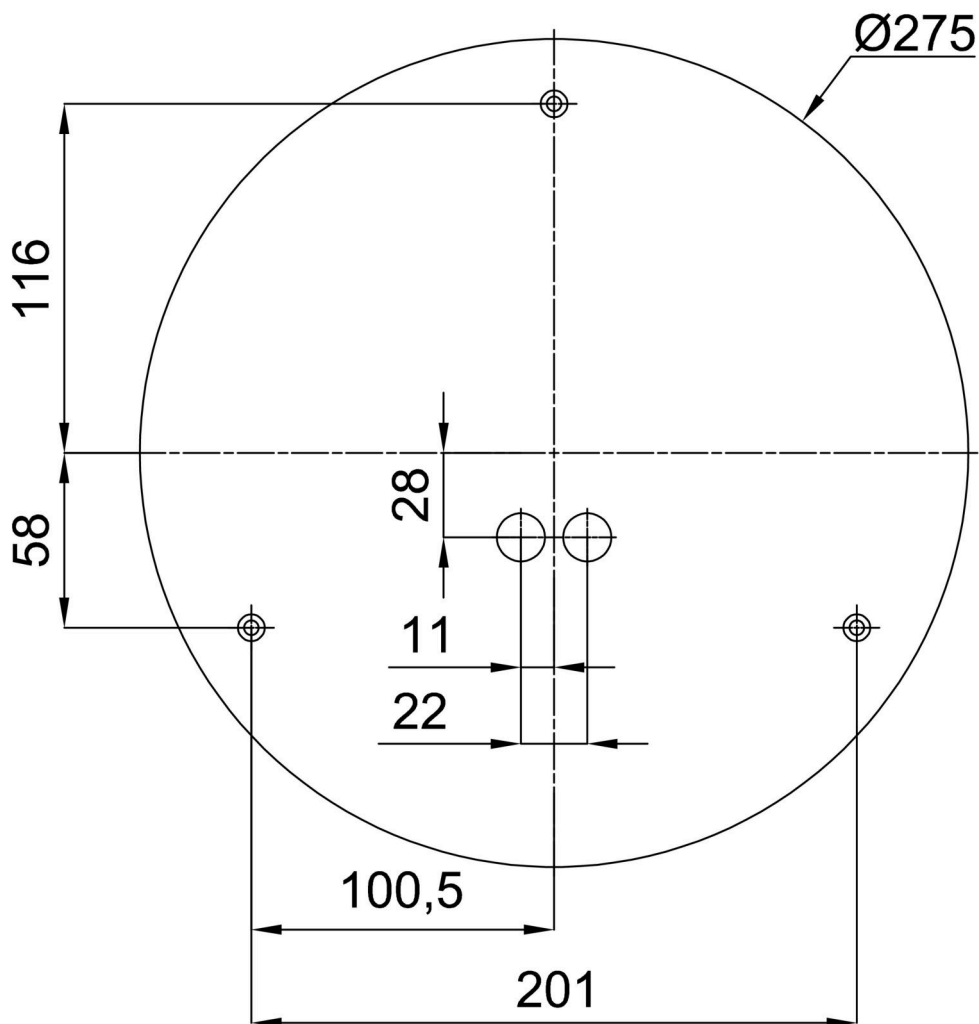

Additional assortment:

Base for surface mounting

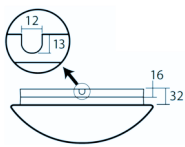
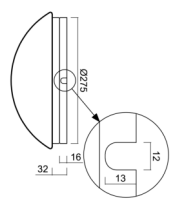
Product code	Name	Color	Description	Picture	Drawing
33501	KN6,K6/BP	white Ra19003			

Lampshade

Product code	Name	Color	Description	Picture	Drawing
20635	FOP1C	white - black		