



## ISIS P4 PM HP

LED-5L08E950Z11/PM4/a5 NK3HST NL 3K##

[WWW.OSMONT.CZ](http://WWW.OSMONT.CZ)

# ISIS P4 PM HP

Product code: ISI60374

Type: LED-5L08E950Z11/PM4/a5 NK3HST NL 3K##

Short description of the luminaire: Stainless steel polished | pendant high-power LED light with emergency backup combined (with Self-test) | PMMA shade | rod pendant 100 cm |

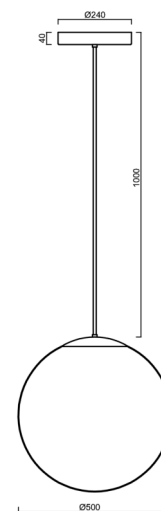

## Technical

Types of luminaires	Emergency combined SELFTEST
Mounting type	Suspended - rod
Base material	stainless steel steel
Shade material	glossy polymethyl methacrylate
Base color	polished stainless steel
Shade color	white
Holding the shade	steel holder
Mounting location	ceiling
Width	500 mm
Length	500 mm
Height	500 mm
Hinge length	1000 mm
mounting holes (diameter)	3xØ5mm
Cable entrance	2xØ16mm
Energy Class	D
Impact strength	IK06
Operating temperature	from -20°C to +30°C

## Electric

Power consumption	59 W
Ingress Protection	IP40
Socket	LED modul
Battery type	LiFePO4
Emergency time	3 hours
SELFTEST	yes
terminal block	snap terminal block

## Luminous

Lum. flux of luminaire	8100 lm
Lum. flux of light source	9200 lm
Lum. flux of light source in emergency mode	200 lm
Temperature	3000 K
Rated life time LED L80/B10	100000 hours
CRI	Ra80
MacAdam	3
Blue light hazard	Risk group 0

Eulum data for calculation programs are available at [www.osmont.cz](http://www.osmont.cz).



Logistic

EAN	8591728152581
Weight NTTO	4.4 Kg
Weight BTTO	6.3 Kg
Number of cartons	2 pcs
Package volume	0.185 m <sup>3</sup>
Package 1 width	0.52 m
Package 1 length	0.52 m
Package 1 height	0.53 m
Warranty*	60 months

\*The warranty for the batteries is valid for 12 months from the date of purchase.

Installation dimensions:

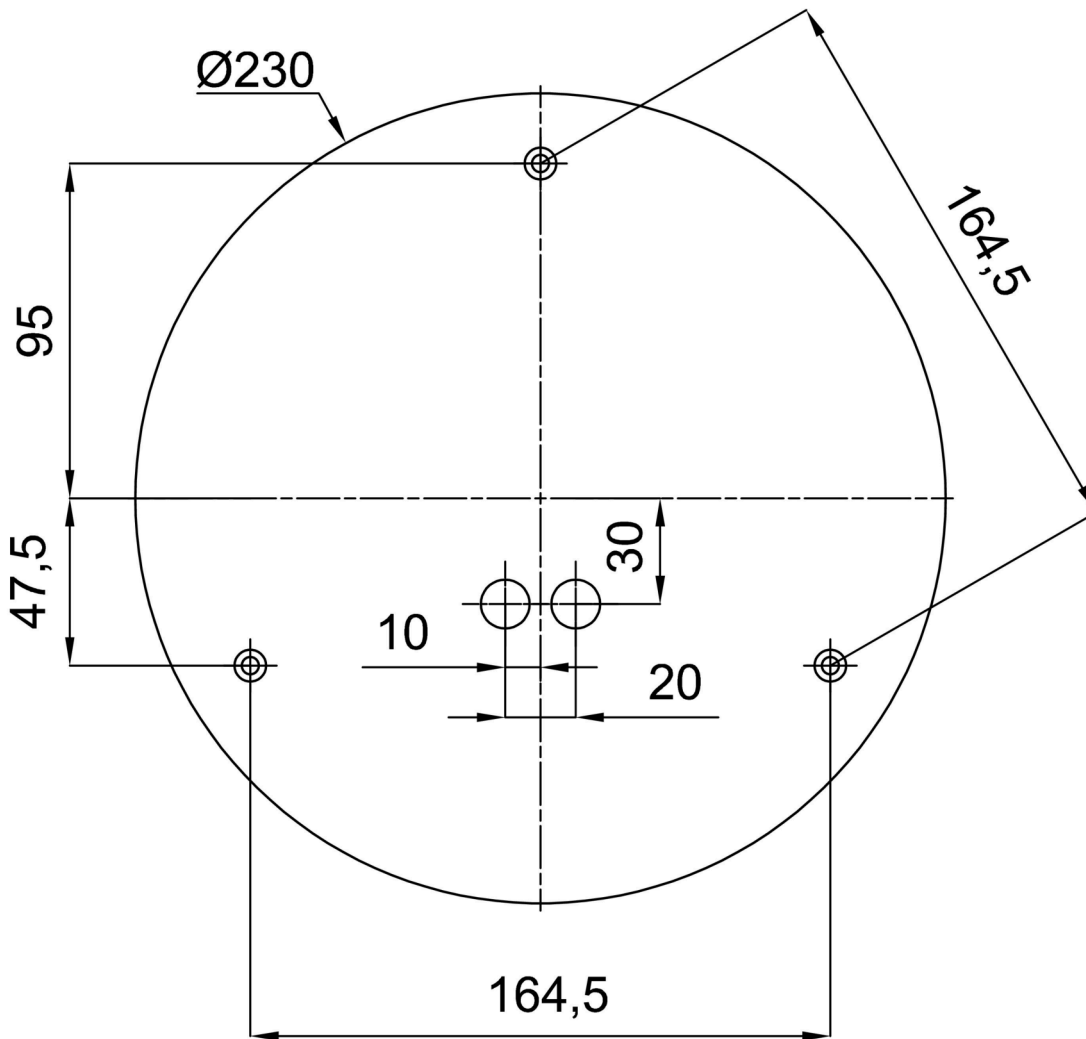

## Additional assortment:

## Lampshade

Product code	Name	Color	Description	Picture	Drawing
20603	PM4	white	příslušenství		