

## ERIS LEC4

---

LED-1L23E700ZLE910/414C/L100 C 3K##

[WWW.OSMONT.CZ](http://WWW.OSMONT.CZ)

# ERIS LEC4

Product code: ERI67416

Type: LED-1L23E700ZLE910/414C/L100 C 3K##

Short description of the luminaire: Black pendant LED light ON/OFF with TRIPLEX OPAL glass shadewith black decorative stripe.



## Technical

Types of luminaires	Classic on/off
Mounting type	Suspended - SELV wire (cableless)
Base material	steel
Shade material	three-layer glass TRIPLEX OPAL
Base color	black Ral9005
Shade color	white - black
Holding the shade	folding system
Mounting location	ceiling
Width	540 mm
Length	540 mm
Height	145 mm
Diameter	ø 540 mm
Hinge length	1000 mm
mounting holes (diameter)	3xø5mm
Installation wire (diameter)	2xø16mm
Energy Class	D
Impact strength	IK01
Operating temperature	from -20°C to +30°C

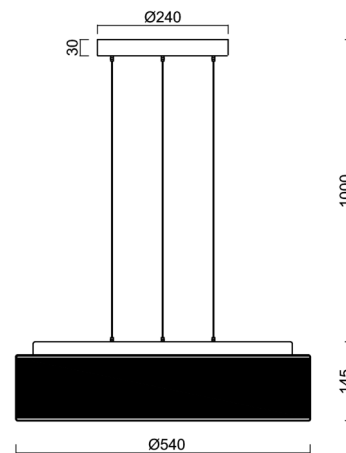
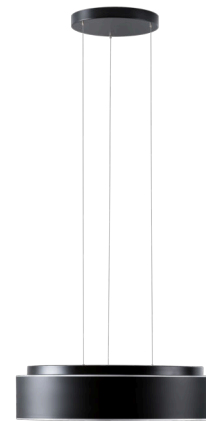

## Electric

Power consumption	35 W
Ingress Protection	IP40
Socket	LED modul
terminal block	snap terminal block
Automatic circuit breaker type B10A	11 pcs
Automatic circuit breaker type B16A	17 pcs
Automatic circuit breaker type C10A	18 pcs
Automatic circuit breaker type C16A	28 pcs

## Luminous

Lum. flux of luminaire	2810 lm
Lum. flux of light source	5610 lm
Luminaire efficacy	80 lm/W
Temperature	3000 K
Rated life time LED L80/B10	100000 hours
CRI	Ra80
MacAdam	3
Blue light hazard	Risk group 0



# TECHNICAL SHEET



Eulum data for calculation programs are available at [www.osmont.cz](http://www.osmont.cz).

## Logistic

EAN	8591728118556
Weight NTTO	9.25 Kg
Weight BTTO	10.05 Kg
Number of cartons	1 pcs
Package volume	0.086 m <sup>3</sup>
Package 1 width	0.6 m
Package 1 length	0.6 m
Package 1 height	0.24 m
Warranty*	60 months

\*The warranty for the batteries is valid for 12 months from the date of purchase.

## Installation dimensions:

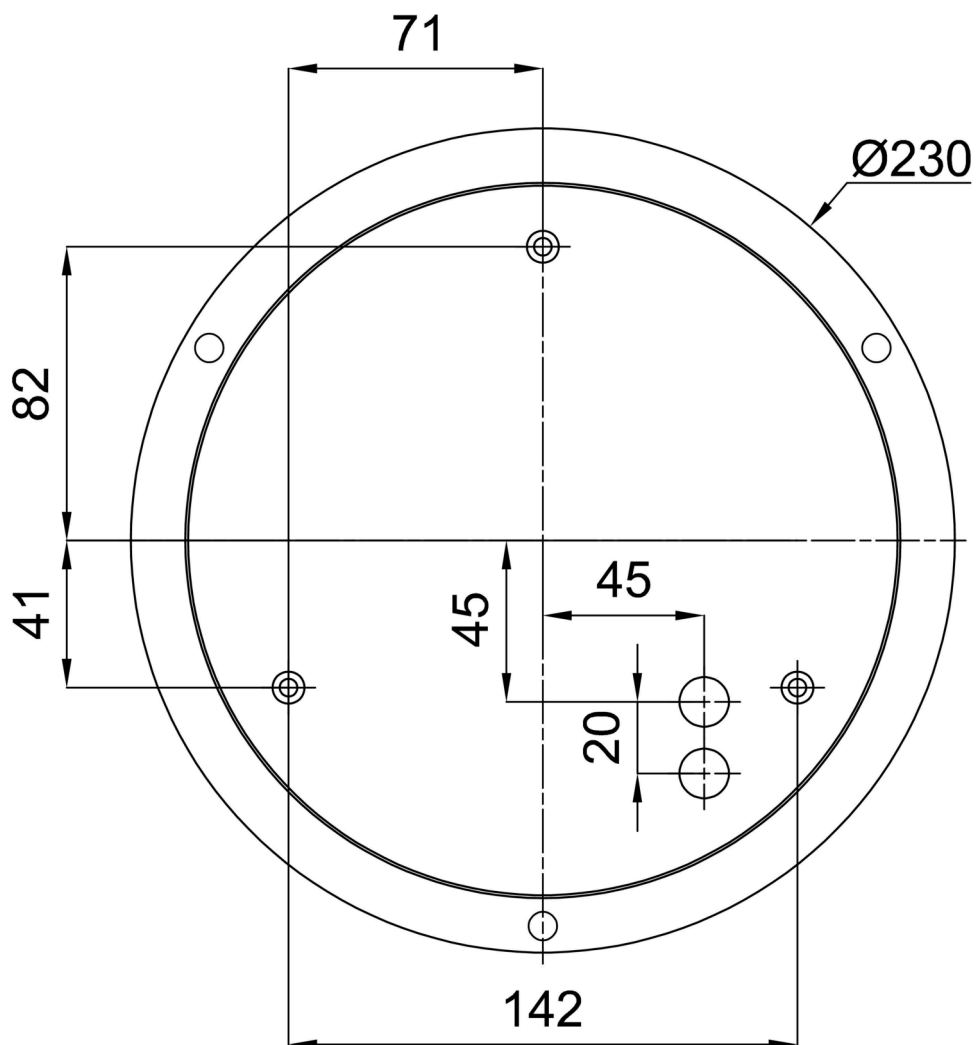

## Additional assortment:

## Lampshade

Product code	Name	Color	Description	Picture	Drawing
20133	414C	white - black		