

ERIS LEC2

LED-1L14E500ZLE64/412C/L100 B 3/4K#

WWW.OSMONT.CZ

ERIS LEC2

Product code: ERI71351

Type: LED-1L14E500ZLE64/412C/L100 B 3/4K#

Short description of the luminaire: White pendant LED light ON/OFF with TRIPLEX OPAL glass shade with black decorative stripe.

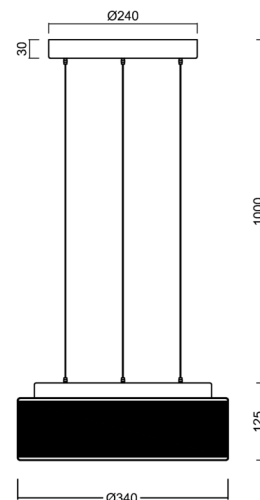
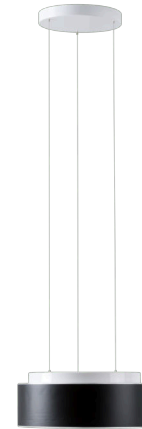

Technical

Types of luminaires	Classic on/off
Mounting type	Suspended - SELV wire (cableless)
Base material	steel
Shade material	three-layer glass TRIPLEX OPAL
Base color	white Ra9003
Shade color	white - black
Holding the shade	folding system
Mounting location	ceiling
Width	340 mm
Length	340 mm
Height	125 mm
Diameter	ø 340 mm
Hinge length	1000 mm
mounting holes (diameter)	3xø5mm
Installation wire (diameter)	2xø16mm
Energy Class	D
Impact strength	IK01
Operating temperature	from -20°C to +30°C

Electric

Power consumption	13 W
Ingress Protection	IP40
Socket	LED modul
terminal block	snap terminal block
Automatic circuit breaker type B10A	31 pcs
Automatic circuit breaker type B16A	50 pcs
Automatic circuit breaker type C10A	52 pcs
Automatic circuit breaker type C16A	85 pcs

Luminous

Lum. flux of luminaire	1000/1040 lm
Lum. flux of light source	2000/2080 lm
Luminaire efficacy	76 lm/W
Temperature	3000/4000 K
Rated life time LED L80/B10	100000 hours
CRI	Ra80
MacAdam	3
Blue light hazard	Risk group 0

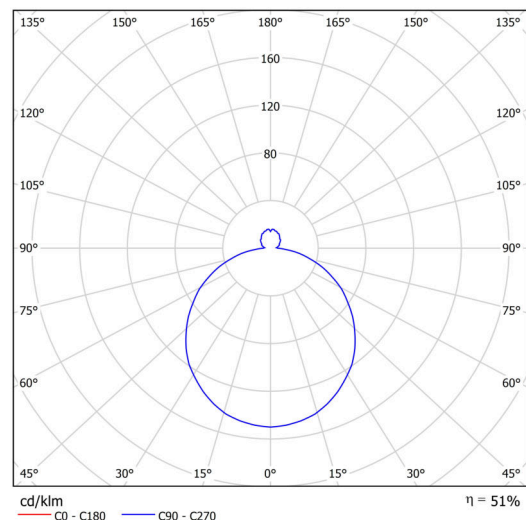

TECHNICAL SHEET



Eulum data for calculation programs are available at www.osmont.cz.

Logistic

EAN	8591728120672
Weight NTTO	3.9 Kg
Weight BTTO	4.3 Kg
Number of cartons	1 pcs
Package volume	0.032 m ³
Package 1 width	0.38 m
Package 1 length	0.38 m
Package 1 height	0.22 m
Warranty*	60 months

*The warranty for the batteries is valid for 12 months from the date of purchase.

Installation dimensions:

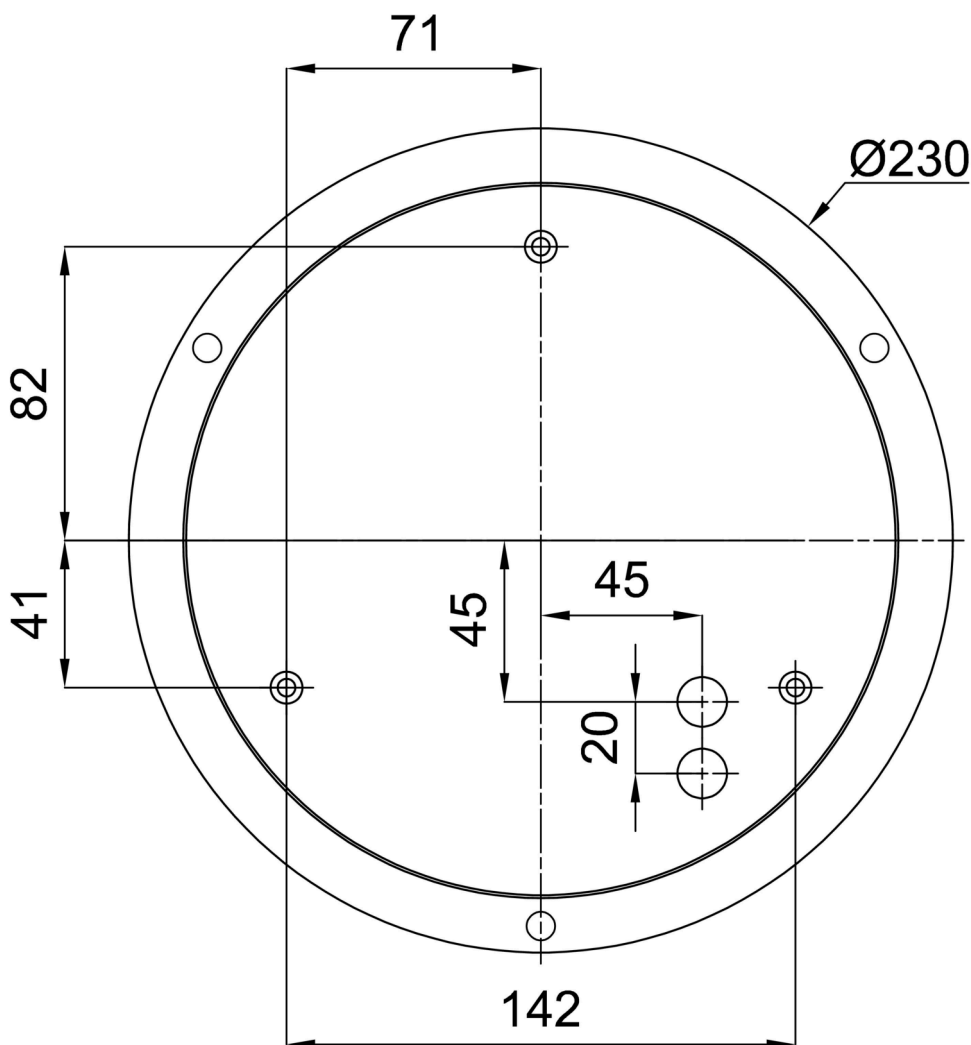

Additional assortment:

Lampshade

Product code	Name	Color	Description	Picture	Drawing
20131	412C	white - black		