



## ELSA 3

---

LED-1L15E500BT14/027 HF 3/4K#

[WWW.OSMONT.CZ](http://WWW.OSMONT.CZ)

# ELSA 3

Product code: ELS71218

Type: LED-1L15E500BT14/027 HF 3/4K#

Short description of the luminaire: White surface-mounted changeable LED light with sensor with TRIPLEX OPAL glass shade

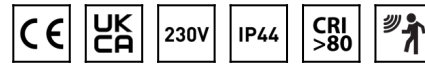

## Technical

Types of luminaires	Sensor
Mounting type	surface mounted
Base material	steel
Shade material	three-layer glass TRIPLEX OPAL
Base color	white Ral9003
Shade color	white
Holding the shade	bayonet
Mounting location	ceiling/wall
Width	360 mm
Length	360 mm
Height	88 mm
Diameter	ø 360 mm
mounting holes (diameter)	3xø5mm
Installation wire (diameter)	2xø16mm
Energy Class	D
Impact strength	IK01
Operating temperature	from -20°C to +30°C

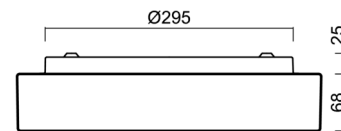
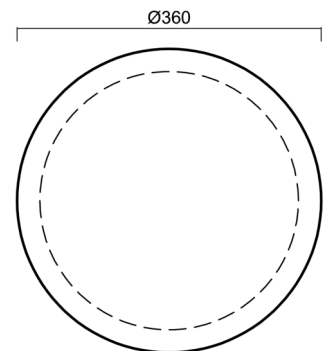

## Electric

Power consumption	19 W
Ingress Protection	IP44
Socket	LED modul
Sensor	HF
terminal block	snap terminal block
Automatic circuit breaker type B10A	37 pcs
Automatic circuit breaker type B16A	59 pcs
Automatic circuit breaker type C10A	37 pcs
Automatic circuit breaker type C16A	59 pcs

## Luminous

Lum. flux of luminaire	2100/2190 lm
Lum. flux of light source	3000/3130 lm
Luminaire efficacy	110 lm/W
Temperature	3000/4000 K
Rated life time LED L80/B10	100000 hours
CRI	Ra80
MacAdam	3
Blue light hazard	Risk group 0

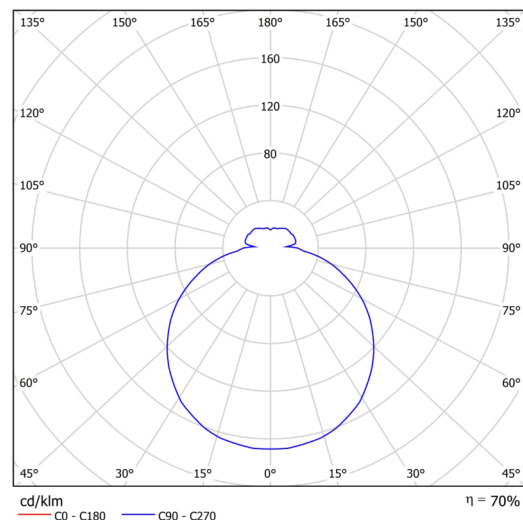

Eulum data for calculation programs are available at [www.osmont.cz](http://www.osmont.cz).

Logistic

EAN	8591728098063
Weight NTTO	3.1 Kg
Weight BTTO	3.4 Kg
Number of cartons	1 pcs
Package volume	0.016 m <sup>3</sup>
Package 1 width	0.375 m
Package 1 length	0.355 m
Package 1 height	0.12 m
Warranty*	60 months

\*The warranty for the batteries is valid for 12 months from the date of purchase.

Installation dimensions:

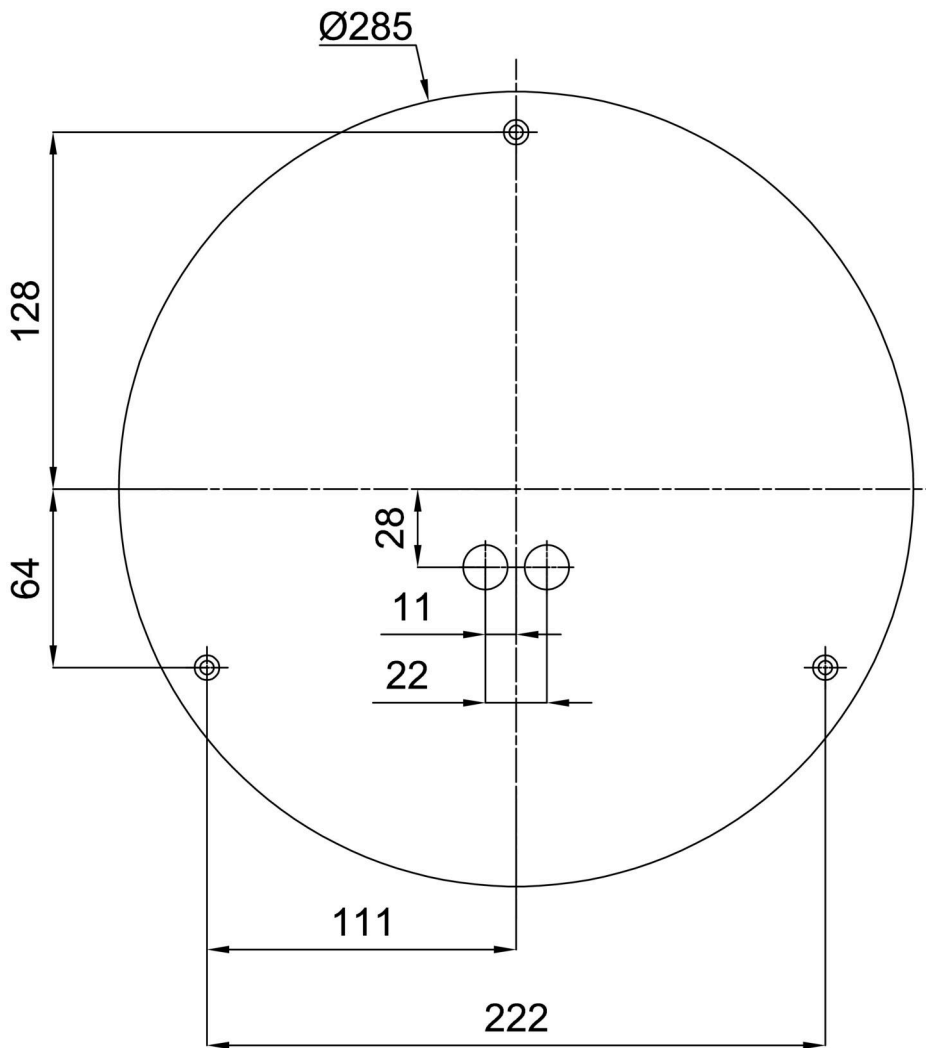

Additional assortment:

Decorative collar

Product code	Name	Color	Description	Picture	Drawing
30136	B14/X14	polished stainless steel	the collar is held by the shade		
30135	B14/X4	white Ral9003	the collar is held by the shade		
30138	B14/X13	grey	the collar is held by the shade		
30137	B14/X12	polished brass	the collar is held by the shade		

Base for surface mounting

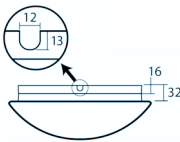
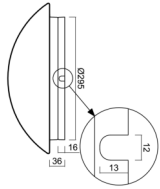
Product code	Name	Color	Description	Picture	Drawing
33505	B14/BP	white Ral9003			

Lampshade

Product code	Name	Color	Description	Picture	Drawing
20082	027	white		