



ELSA 2

LED-1L14E350BT13/025/NK1W 3K#

WWW.OSMONT.CZ

ELSA 2

Product code: ELS59075

Type: LED-1L14E350BT13/025/NK1W 3K#

Short description of the luminaire: White surface-mounted LED light with emergency unit combined with TRIPLEX OPAL glass shade.



Technical

Types of luminaires	Emergency combined
Mounting type	surface mounted
Base material	steel
Shade material	three-layer glass TRIPLEX OPAL
Base color	white Ral9003
Shade color	white
Holding the shade	bayonet
Mounting location	ceiling/wall
Width	300 mm
Length	300 mm
Height	86 mm
Diameter	ø 300 mm
mounting holes (diameter)	3xø5mm
Installation wire (diameter)	2xø16mm
Energy Class	D
Impact strength	IK01
Operating temperature	from 0°C to +30°C

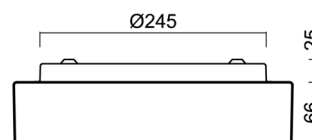
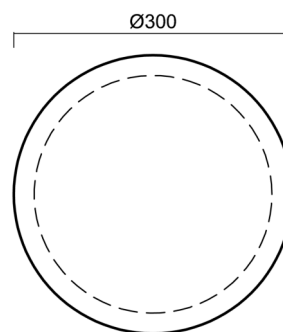

Electric

Power consumption	9 W
Ingress Protection	IP44
Socket	LED modul
Battery type	NiCd
Emergency time	3 hours
terminal block	snap terminal block
Automatic circuit breaker type B10A	32 pcs
Automatic circuit breaker type B16A	48 pcs
Automatic circuit breaker type C10A	57 pcs
Automatic circuit breaker type C16A	86 pcs

Luminous

Lum. flux of luminaire	1040 lm
Lum. flux of light source	1420 lm
Lum. flux of light source in emergency mode	150 lm
Luminaire efficacy	115 lm/W
Temperature	3000 K
Rated life time LED L80/B10	100000 hours
CRI	Ra80
MacAdam	3

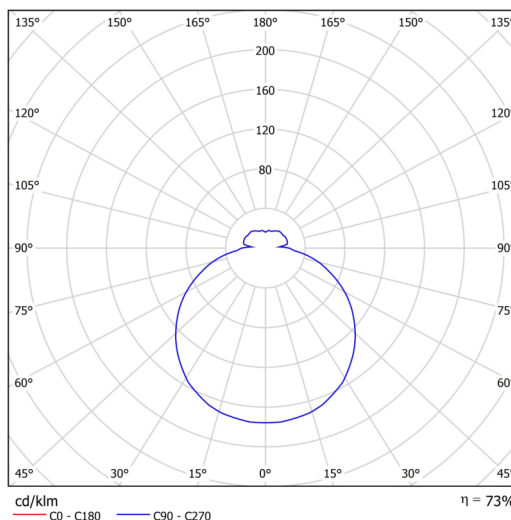

TECHNICAL SHEET



Blue light hazard	Risk group 0
-------------------	--------------

Eulum data for calculation programs are available at www.osmont.cz.

Logistic

EAN	8591728095390
Weight NTTO	2.1 Kg
Weight BTTO	2.4 Kg
Number of cartons	1 pcs
Package volume	0.012 m ³
Package 1 width	0.32 m
Package 1 length	0.31 m
Package 1 height	0.12 m
Warranty*	60 months

*The warranty for the batteries is valid for 12 months from the date of purchase.

Installation dimensions:

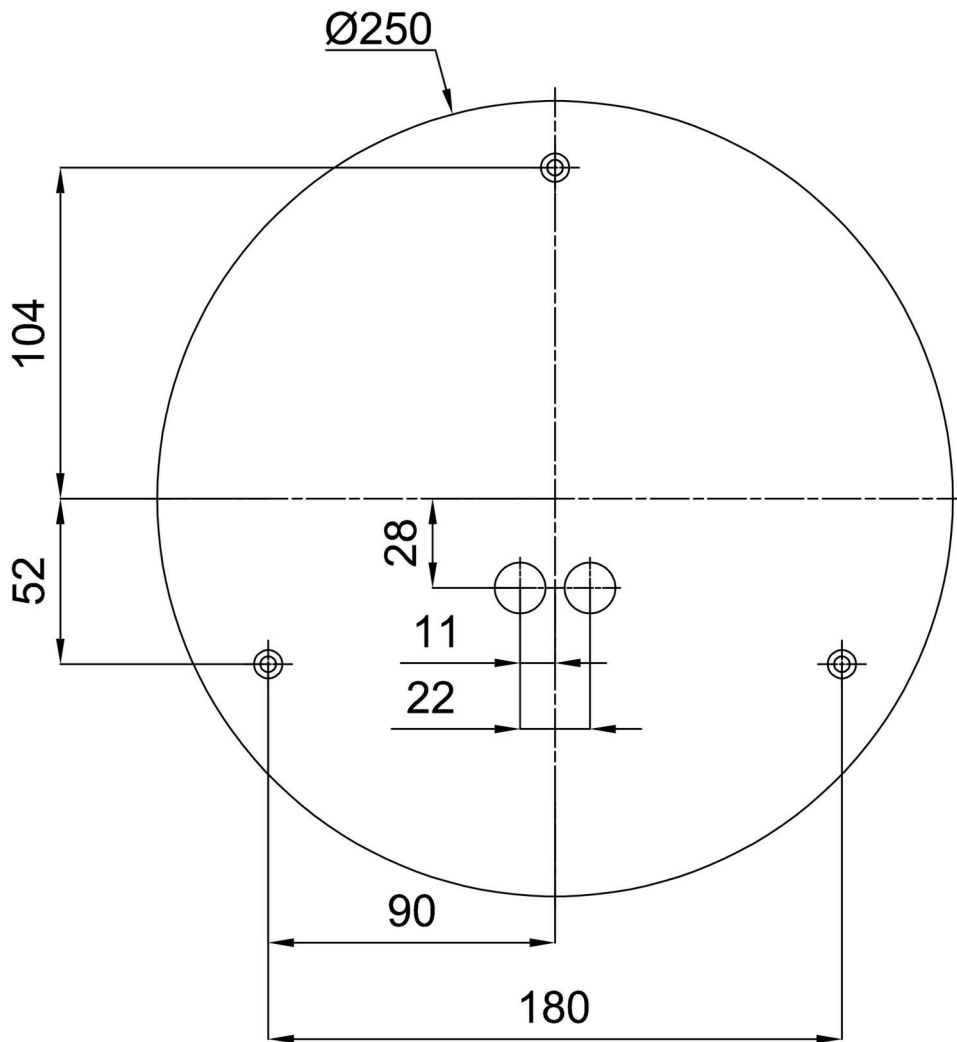

Additional assortment:

Decorative collar

Product code	Name	Color	Description	Picture	Drawing
30069	B13/X14	polished stainless steel	the collar is held by the shade		
30068	B13/X4	white Ral9003	the collar is held by the shade		
30071	B13/X13	grey	the collar is held by the shade		
30070	B13/X12	polished brass	the collar is held by the shade		

Base for surface mounting

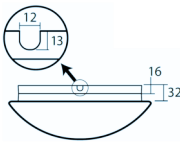
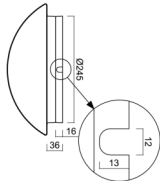
Product code	Name	Color	Description	Picture	Drawing
33504	B13/BP	white Ral9003			

Lampshade

Product code	Name	Color	Description	Picture	Drawing
20081	025	white		