



ELISA

LED-1L43E1050NU43/PC43 DALI 4K#

WWW.OSMONT.CZ

ELISA

Product code: ELI56898

Type: LED-1L43E1050NU43/PC43 DALI 4K#

Short description of the luminaire: White surface-mounted LED light DALI and polycarbonate shade.

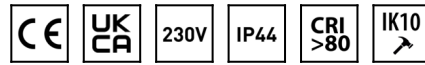

Technical

Types of luminaires	Dimmable
Mounting type	surface mounted
Base material	steel
Shade material	opal polycarbonate
Base color	white Ra9003
Shade color	white
Holding the shade	folding system
Mounting location	wall
Width	490 mm
Length	265 mm
Height	85 mm
mounting holes (diameter)	3xØ5mm
Installation wire (diameter)	2xØ16mm
Energy Class	D
Impact strength	IK10
Operating temperature	from -20°C to +30°C

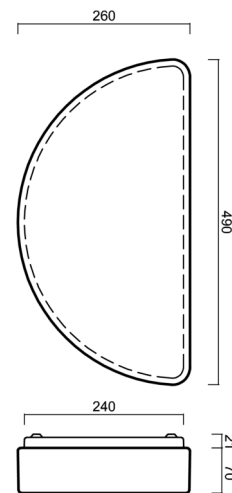

Electric

Power consumption	26 W
Ingress Protection	IP44
Socket	LED modul
terminal block	snap terminal block
Automatic circuit breaker type B10A	18 pcs
Automatic circuit breaker type B16A	32 pcs
Automatic circuit breaker type C10A	30 pcs
Automatic circuit breaker type C16A	53 pcs

Luminous

Lum. flux of luminaire	2920 lm
Lum. flux of light source	4290 lm
Luminaire efficacy	112 lm/W
Temperature	4000 K
Rated life time LED L80/B10	100000 hours
CRI	Ra80
MacAdam	3
Blue light hazard	Risk group 0

Eulum data for calculation programs are available at www.osmont.cz.

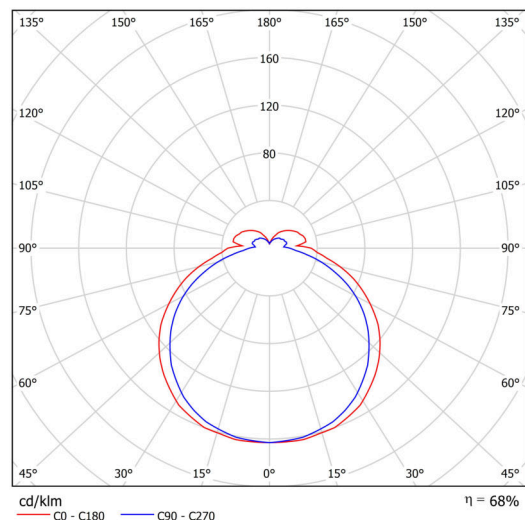

Logistic

EAN	8591728095253
Weight NTTO	1.55 Kg
Weight BTTO	1.85 Kg
Number of cartons	1 pcs
Package volume	0.153 m ³
Package 1 width	0.435 m
Package 1 length	0.415 m
Package 1 height	0.85 m
Warranty*	60 months

*The warranty for the batteries is valid for 12 months from the date of purchase.

Installation dimensions:

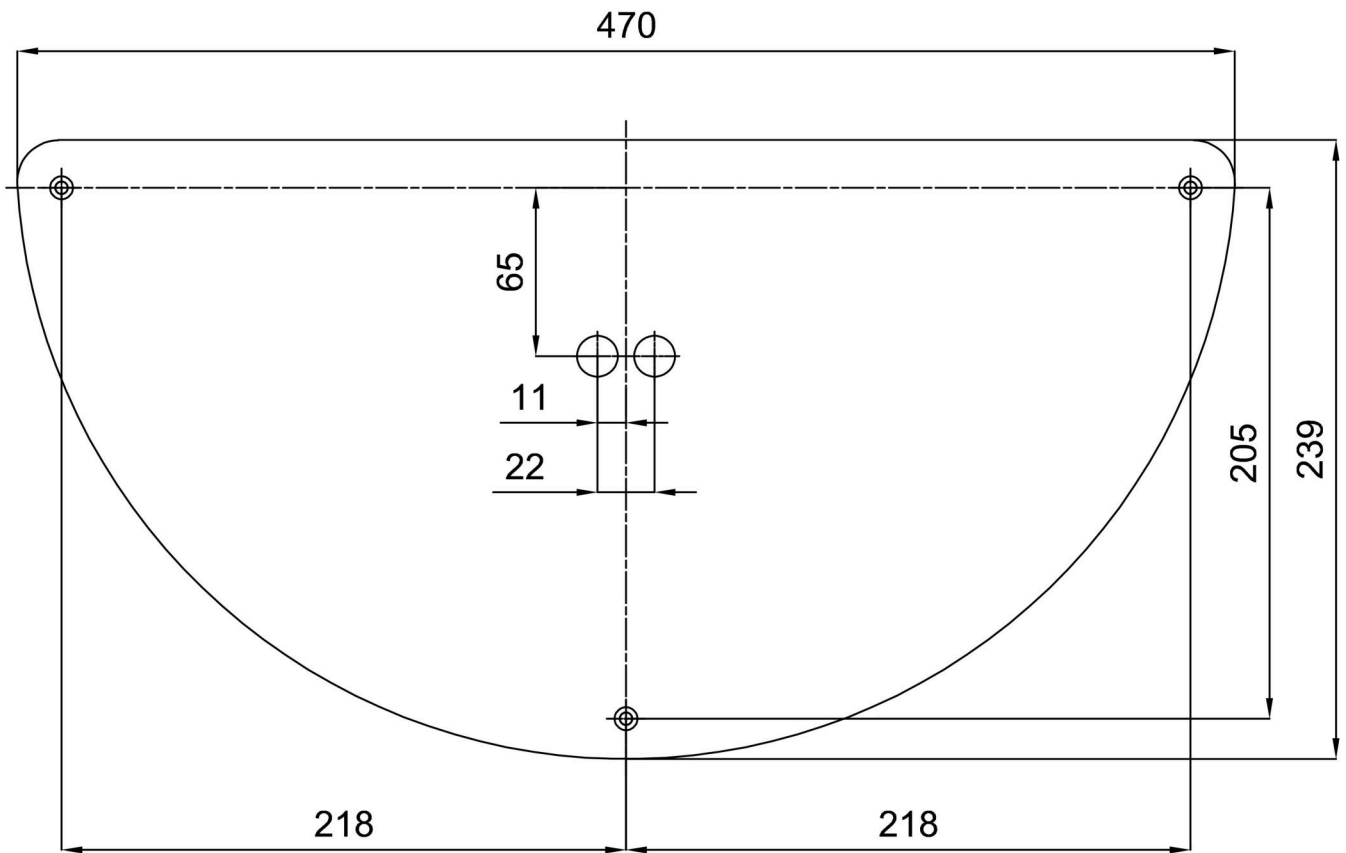

Additional assortment:

Lampshade

Product code	Name	Color	Description	Picture	Drawing
20537	PC43	white		