

EDNA LE5

LED-1L16E700ZLE88/028/L100 B 4K#

WWW.OSMONT.CZ

EDNA LE5

Product code: EDN73567

Type: LED-1L16E700ZLE88/028/L100 B 4K#

Short description of the luminaire: White color | pendant LED light | ON/OFF | TRIPLEX OPAL glass shade with matt surface



Technical

Types of luminaires	Classic on/off
Mounting type	Suspended - SELV wire (cableless)
Base material	steel
Shade material	three-layer glass TRIPLEX OPAL
Base color	white Ra19003
Shade color	white
Holding the shade	folding system
Mounting location	ceiling
Width	490 mm
Length	490 mm
Height	130 mm
Diameter	ø 490 mm
Hinge length	1000 mm
mounting holes (diameter)	3xø5mm
Installation wire (diameter)	2xø16mm
Energy Class	D
Impact strength	IK01
Operating temperature	from -20°C to +30°C



Electric

Power consumption	34 W
Ingress Protection	IP40
Socket	LED modul
terminal block	snap terminal block
Automatic circuit breaker type B10A	11 pcs
Automatic circuit breaker type B16A	17 pcs
Automatic circuit breaker type C10A	18 pcs
Automatic circuit breaker type C16A	28 pcs

Luminous

Lum. flux of luminaire	3480 lm
Lum. flux of light source	5270 lm
Luminaire efficacy	102 lm/W
Temperature	4000 K
Rated life time LED L80/B10	100000 hours
CRI	Ra80
MacAdam	3
Blue light hazard	Risk group 0

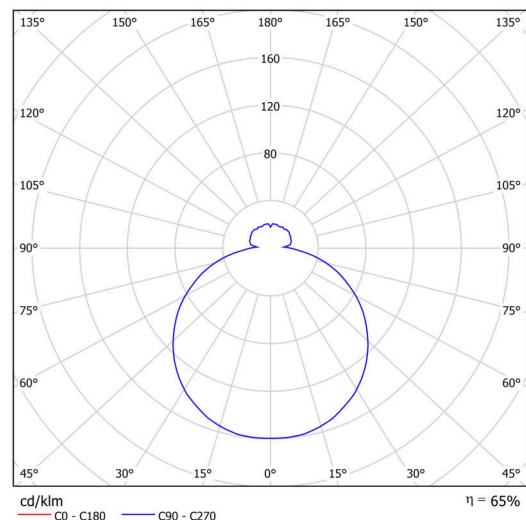

Eulum data for calculation programs are available at

Logistic

EAN	8591728094782
Weight NTTO	6.9 Kg
Weight BTTO	7.4 Kg
Number of cartons	1 pcs
Package volume	0.057 m ³
Package 1 width	0.52 m
Package 1 length	0.52 m
Package 1 height	0.21 m
Warranty*	60 months

*The warranty for the batteries is valid for 12 months from the date of purchase.

Installation dimensions:

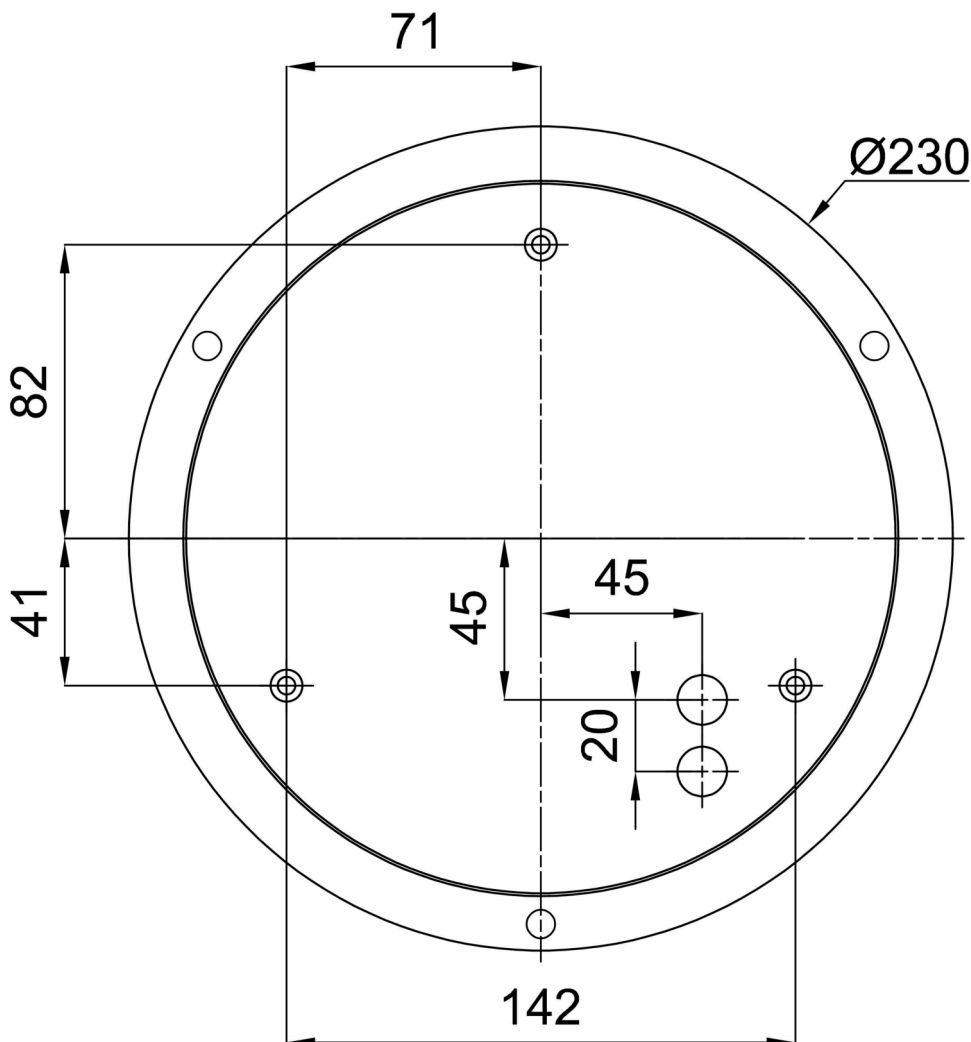

Additional assortment:

Lampshade

Product code	Name	Color	Description	Picture	Drawing
20070	028	white		