



EDNA 4

LED-1L15EMP700K74/026 NK3HST HF 4K#

WWW.OSMONT.CZ

EDNA 4

Product code: EDN61724

Type: LED-1L15EMP700K74/026 NK3HST HF 4K#

Short description of the luminaire: White colour | ceiling or wall LED light with emergency backup combined (with Self-test) with HF sensor |TRIPLEX OPAL hand blown glass shade



Technical

Types of luminaires	Emergency combined + sensor
Mounting type	surface mounted
Base material	steel
Shade material	three-layer glass TRIPLEX OPAL
Base color	white Ral9003
Shade color	white
Holding the shade	folding system
Mounting location	ceiling/wall
Width	420 mm
Length	420 mm
Height	115 mm
mounting holes (diameter)	4xØ5mm
Cable entrance	2xØ16mm
Energy Class	D
Impact strength	IK01
Operating temperature	from -20°C to +30°C

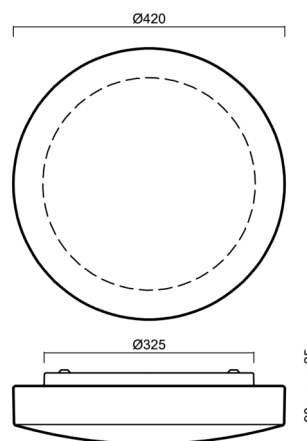

Electric

Power consumption	27 W
Ingress Protection	IP43
Socket	LED modul
Battery type	LiFePO4
Emergency time	3 hours
SELFTEST	yes
terminal block	snap terminal block

Luminous

Lum. flux of luminaire	2740 lm
Lum. flux of light source	4220 lm
Lum. flux of light source in emergency mode	200 lm
Temperature	4000 K
Rated life time LED L80/B10	100000 hours
CRI	Ra80
MacAdam	3
Blue light hazard	Risk group 0

Eulum data for calculation programs are available at www.osmont.cz.

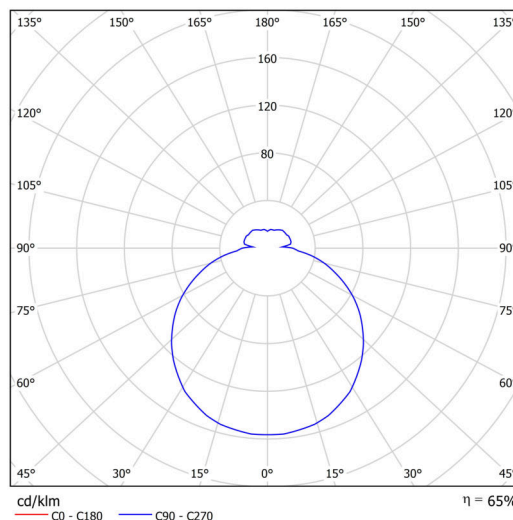

Logistic

EAN	8591728150730
Weight NTTO	4 Kg
Weight BTTO	4.4 Kg
Number of cartons	1 pcs
Package volume	0.025 m ³
Package 1 width	0.435 m
Package 1 length	0.435 m
Package 1 height	0.13 m
Warranty*	60 months

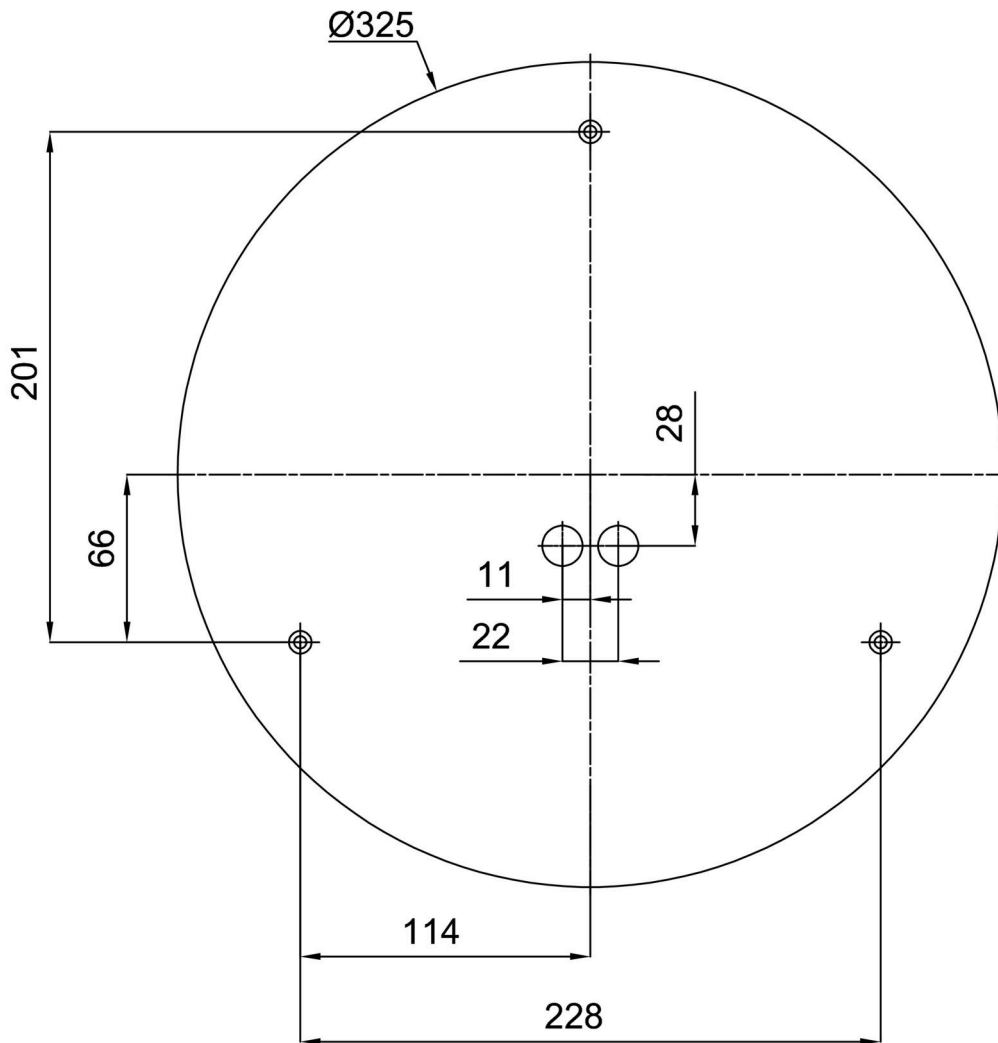

*The warranty for the batteries is valid for 12 months from the date of purchase.

Installation dimensions:



Additional assortment:

Decorative collar

Product code	Name	Color	Description	Picture	Drawing
30131	K74/DL15	brushed stainless steel	příslušenství		
30130	K74/DL14	polished stainless steel	příslušenství		
30129	K74/DL4	white Ral9003	příslušenství		

Lampshade

Product code	Name	Color	Description	Picture	Drawing
20054	026	white	příslušenství		