

DELIA LEC2

LED-1L16E700ZLEN83/PC23C/L100 3K#

WWW.OSMONT.CZ

DELIA LEC2

Product code: DEL69402

Type: LED-1L16E700ZLEN83/PC23C/L100 3K#

Short description of the luminaire: White pendant LED light ON/OFF and polycarbonate shade.



Technical

Types of luminaires	Classic on/off
Mounting type	Suspended - SELV wire (cableless)
Base material	steel
Shade material	opal polycarbonate
Base color	white Ral9003
Shade color	white - black
Holding the shade	folding system
Mounting location	ceiling
Width	400 mm
Length	400 mm
Height	80 mm
Diameter	ø 400 mm
Hinge length	1000 mm
mounting holes (diameter)	3xø5mm
Installation wire (diameter)	2xø16mm
Energy Class	D
Impact strength	IK10
Operating temperature	from -20°C to +30°C

Electric

Power consumption	34 W
Ingress Protection	IP40
Socket	LED modul
terminal block	snap terminal block
Automatic circuit breaker type B10A	11 pcs
Automatic circuit breaker type B16A	17 pcs
Automatic circuit breaker type C10A	18 pcs
Automatic circuit breaker type C16A	28 pcs

Luminous

Lum. flux of luminaire	2780 lm
Lum. flux of light source	5050 lm
Luminaire efficacy	81 lm/W
Temperature	3000 K
Rated life time LED L80/B10	100000 hours
CRI	Ra80
MacAdam	3
Blue light hazard	Risk group 0

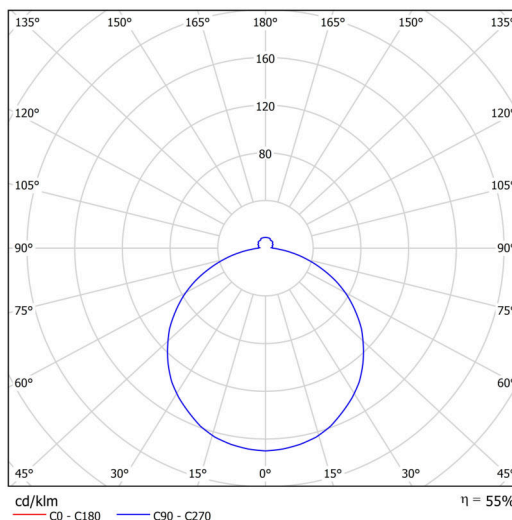
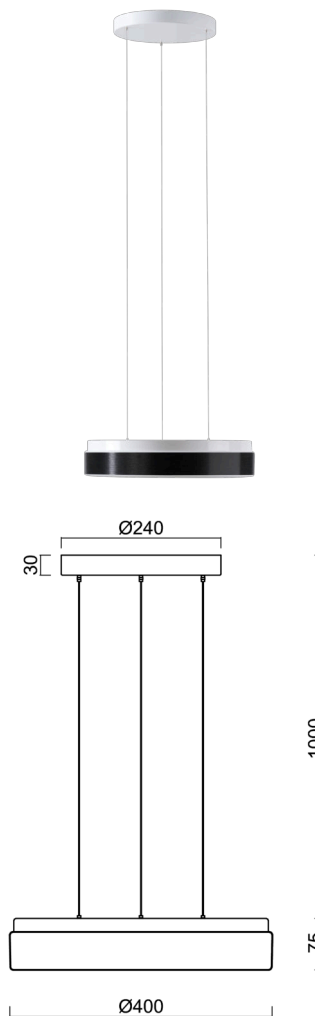

Eulum data for calculation programs are available at www.osmont.cz.

Logistic

EAN	8591728077839
Weight NTTO	2.3 Kg
Weight BTTO	2.7 Kg
Number of cartons	1 pcs
Package volume	0.054 m ³
Package 1 width	0.48 m
Package 1 length	0.46 m
Package 1 height	0.245 m
Warranty*	60 months

*The warranty for the batteries is valid for 12 months from the date of purchase.

Installation dimensions:



Additional assortment:

Lampshade

Product code	Name	Color	Description	Picture	Drawing
20568	PC23C	white - black		