



DELIA L5

IN-62ZLN11/PC26/L100**

WWW.OSMONT.CZ

DELIA L5

Product code: DEL58838

Type: IN-62ZLN11/PC26/L100**

Short description of the luminaire: White colour | pendant E27 light ON/OFF | opal polycarbonate shade (PC) | steel wire pendant (with supply cable) 100 cm |

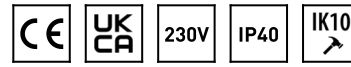

Technical data

Types of luminaires	Classic on/off
Mounting type	Suspended - wire
Base material	steel
Shade material	opal polycarbonate
Base color	white Ral9003
Shade color	white
Holding the shade	folding system
Mounting location	ceiling
Width	900 mm
Length	900 mm
Height	85 mm
Diameter	ø 900 mm
Suspension length	1000 mm
mounting holes (diameter)	2xø5mm
Cable entrance	2xø16mm
Impact strength	IK10
Operating temperature	from -20°C to +30°C

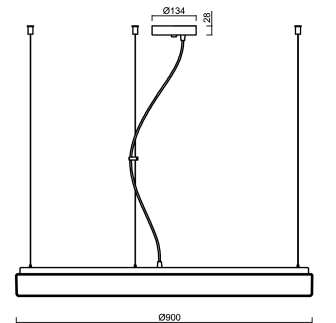

Electrical data

Power consumption	6x25 W
Ingress Protection	IP40
Socket	E27
terminal block	screw terminal block

Luminous data

Blue light hazard	Risk group 0
-------------------	--------------

Eulum data for calculation programs are available at www.osmont.cz.

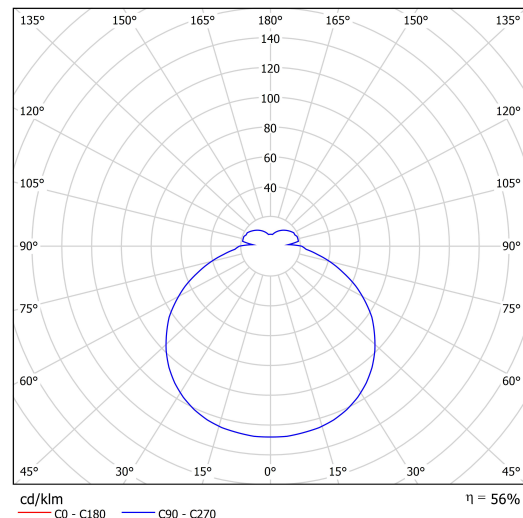

TECHNICAL SHEET



Logistical data

EAN	8591728193317
Weight NTTO	9.3 Kg
Weight BTTO	11.5 Kg
Warranty*	60 months

*The warranty for the batteries is valid for 36 months from the date of purchase.

Installation dimensions:

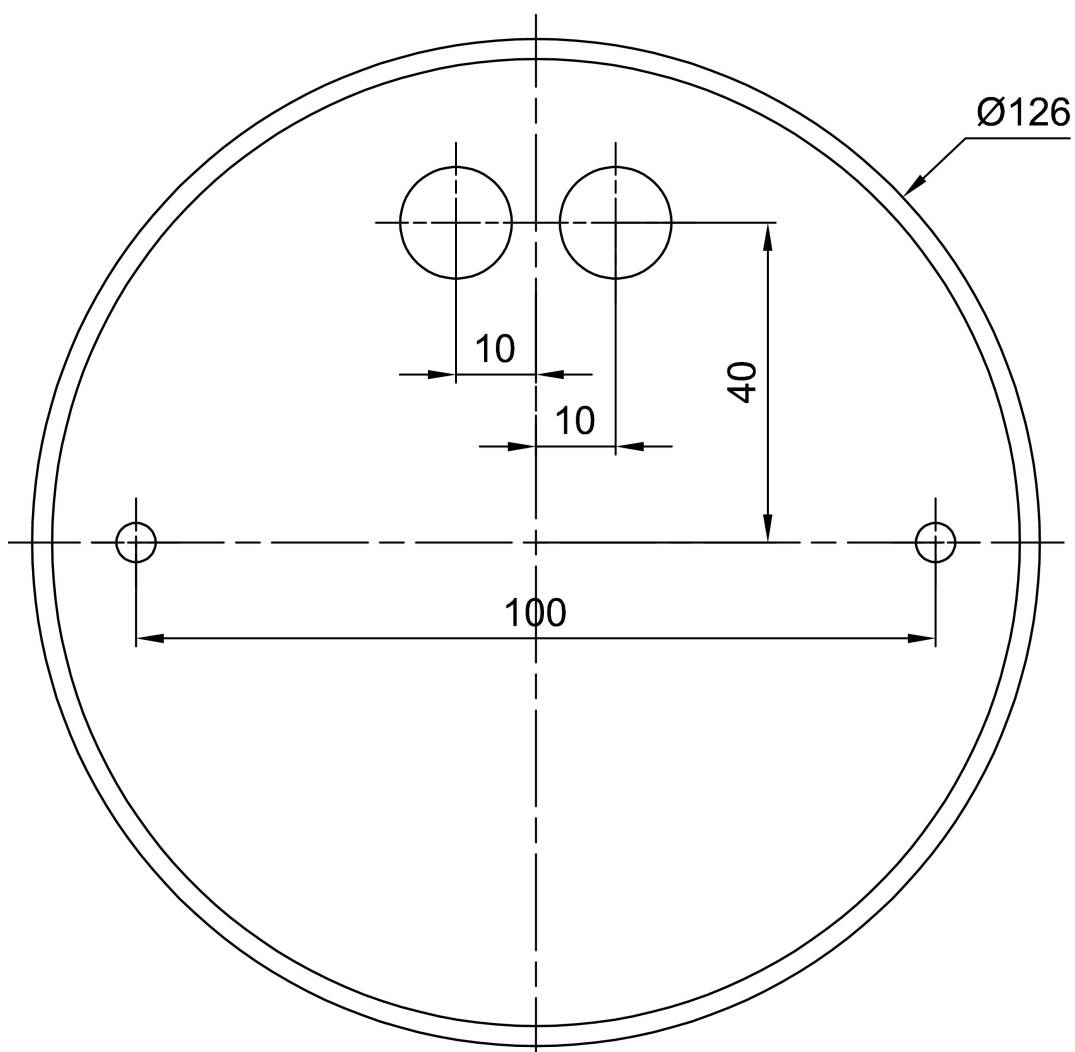

Additional assortment:

Lampshade

Product code	Name	Color	Picture	Drawing
20655	PC26	white	