



DELIA L5

LED-9L52EMP1050ZLN11/PM26/L100 4K##

WWW.OSMONT.CZ

DELIA L5

Product code: DEL48748

Type: LED-9L52EMP1050ZLN11/PM26/L100 4K##

Short description of the luminaire: White pendant LED light ON/OFF and PMMA shade.

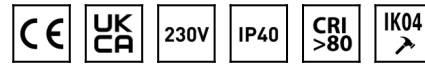

Technical

Types of luminaires	Classic on/off
Mounting type	Suspended - wire
Base material	steel
Shade material	opal polymethyl methacrylate
Base color	white Ra9003
Shade color	white
Holding the shade	folding system
Mounting location	ceiling
Width	900 mm
Length	900 mm
Height	90 mm
Diameter	ø 900 mm
Hinge length	1000 mm
mounting holes (diameter)	2xø5mm
Installation wire (diameter)	2xø16mm
Energy Class	D
Impact strength	IK04
Operating temperature	from -20°C to +30°C

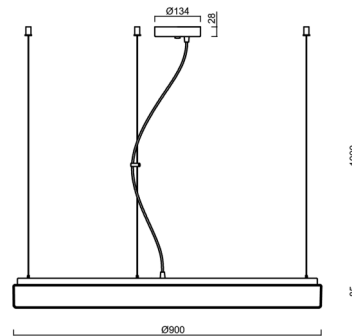

Electric

Power consumption	150 W
Ingress Protection	IP40
Socket	LED modul
terminal block	screw terminal block
Automatic circuit breaker type B10A	8 pcs
Automatic circuit breaker type B16A	13 pcs
Automatic circuit breaker type C10A	8 pcs
Automatic circuit breaker type C16A	13 pcs

Luminous

Lum. flux of luminaire	16600 lm
Lum. flux of light source	23720 lm
Luminaire efficacy	110 lm/W
Temperature	4000 K
Rated life time LED L80/B10	100000 hours
CRI	Ra80
MacAdam	3
Blue light hazard	Risk group 0

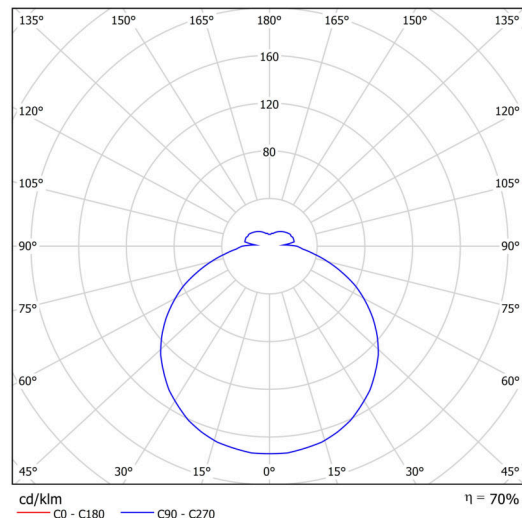

Eulum data for calculation programs are available at www.osmont.cz.

TECHNICAL SHEET



Multipower

Possibility of output adjustment by the user (DIP switch on the current source).

I [mA]	1050	900	850	700	
[%]	100	86	81	67	

Logistic

EAN	8591728073060
Weight NTTO	10.5 Kg
Weight BTTO	13.2 Kg
Number of cartons	1 pcs
Package volume	0.205 m ³
Package 1 width	0.94 m
Package 1 length	0.95 m
Package 1 height	0.23 m
Warranty*	60 months

*The warranty for the batteries is valid for 12 months from the date of purchase.

Installation dimensions:



Additional assortment:

Lampshade

Product code	Name	Color	Description	Picture	Drawing
20536	PM26	white		