



DELIA L2

LED-1L16EMP700ZLN83/PC23/L100/NK1W B 4K#

WWW.OSMONT.CZ

DELIA L2

Product code: DEL48877

Type: LED-1L16EMP700ZLN83/PC23/L100/NK1W B 4K#

Short description of the luminaire: White colour | pendant LED light with emergency backup combined | multipower driver | opal polycarbonate shade (PC)| steel wire pendant (with supply cable) 100 cm |

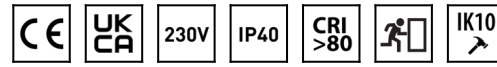

Technical

Types of luminaires	Emergency combined
Mounting type	Suspended - wire
Base material	steel
Shade material	opal polycarbonate
Base color	white Ral9003
Shade color	white
Holding the shade	folding system
Mounting location	ceiling
Width	400 mm
Length	400 mm
Height	80 mm
Diameter	ø 400 mm
Hinge length	1000 mm
mounting holes (diameter)	2xø5mm
Cable entrance	2xø16mm
Energy Class	D
Impact strength	IK10
Operating temperature	from 0°C to +30°C

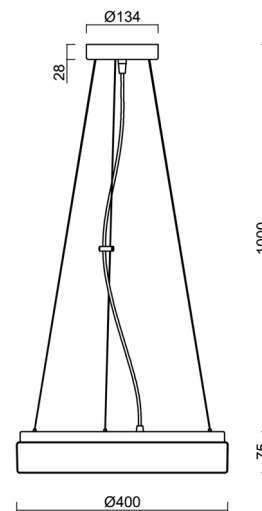

Electric

Power consumption	34 W
Ingress Protection	IP40
Socket	LED modul
Battery type	NiCd
Emergency time	3 hours
terminal block	snap terminal block
Automatic circuit breaker type B10A	26 pcs
Automatic circuit breaker type B16A	40 pcs
Automatic circuit breaker type C10A	30 pcs
Automatic circuit breaker type C16A	48 pcs

Luminous

Lum. flux of luminaire	3690 lm
Lum. flux of light source	5270 lm
Lum. flux of light source in emergency mode	150 lm
Luminaire efficacy	108 lm/W
Temperature	4000 K
Rated life time LED L80/B10	100000 hours
CRI	Ra80

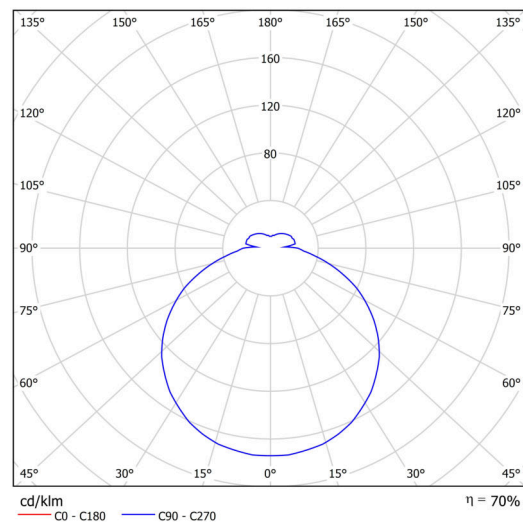

TECHNICAL SHEET



MacAdam	3
Blue light hazard	Risk group 0

Eulum data for calculation programs are available at www.osmont.cz.

Multipower

Possibility of output adjustment by the user (DIP switch on the current source).

I [mA]	700	600	500	400	
[%]	100	86	71	57	

Logistic

EAN	8591728160364
Warranty*	60 months

*The warranty for the batteries is valid for 12 months from the date of purchase.

Installation dimensions:

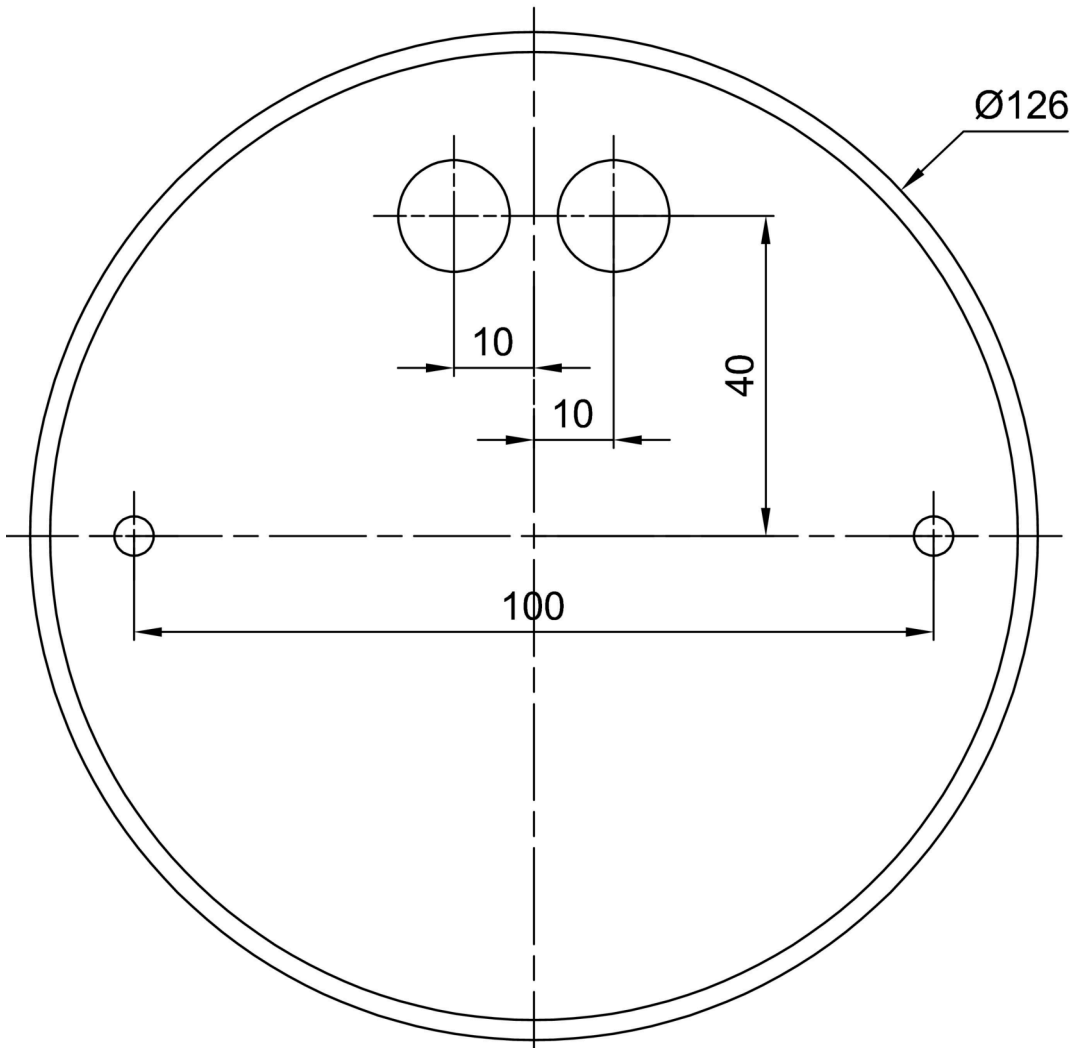

Additional assortment:

Lampshade

Product code	Name	Color	Description	Picture	Drawing
20522	PC23	white		