



## DELIA C1A

---

IN-12KN32/PC21C\*

[WWW.OSMONT.CZ](http://WWW.OSMONT.CZ)

# DELIA C1A

Product code: DEL52585

Type: IN-12KN32/PC21C\*

Short description of the luminaire: White surface-mounted E27 light ON/OFF and polycarbonate shade.

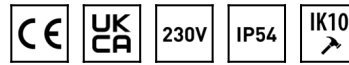

## Technical

Types of luminaires	Classic on/off
Mounting type	surface mounted
Base material	steel
Shade material	opal polycarbonate
Base color	white Ral9003
Shade color	white - black
Holding the shade	folding system
Mounting location	ceiling/wall
Width	220 mm
Length	220 mm
Height	70 mm
Diameter	ø 220 mm
mounting holes (diameter)	3xø5mm
Installation wire (diameter)	2xø16mm
Impact strength	IK10
Operating temperature	from -20°C to +30°C

## Electric

Voltage type	AC
AC voltage	220 - 240 V
Power consumption	25 W
Ingress Protection	IP54
Socket	E27
terminal block	snap terminal block

## Luminous

Blue light hazard	Risk group 0
-------------------	--------------

Eulum data for calculation programs are available at [www.osmont.cz](http://www.osmont.cz).

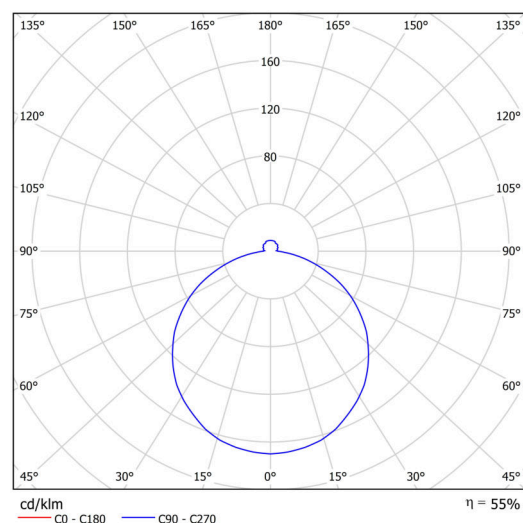
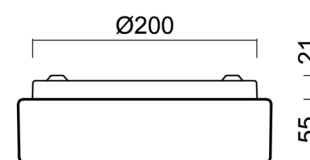
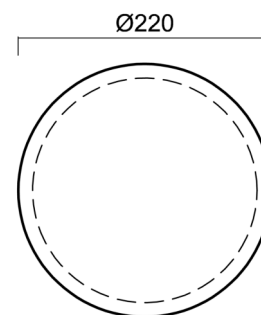

Logistic

EAN	8591728525859
Weight NTTO	0.5 Kg
Weight BTTO	0.6 Kg
Number of cartons	1 pcs
Package volume	0.005 m <sup>3</sup>
Package 1 width	0.25 m
Package 1 length	0.23 m
Package 1 height	0.09 m
Warranty*	60 months

\*The warranty for the batteries is valid for 12 months from the date of purchase.

Installation dimensions:

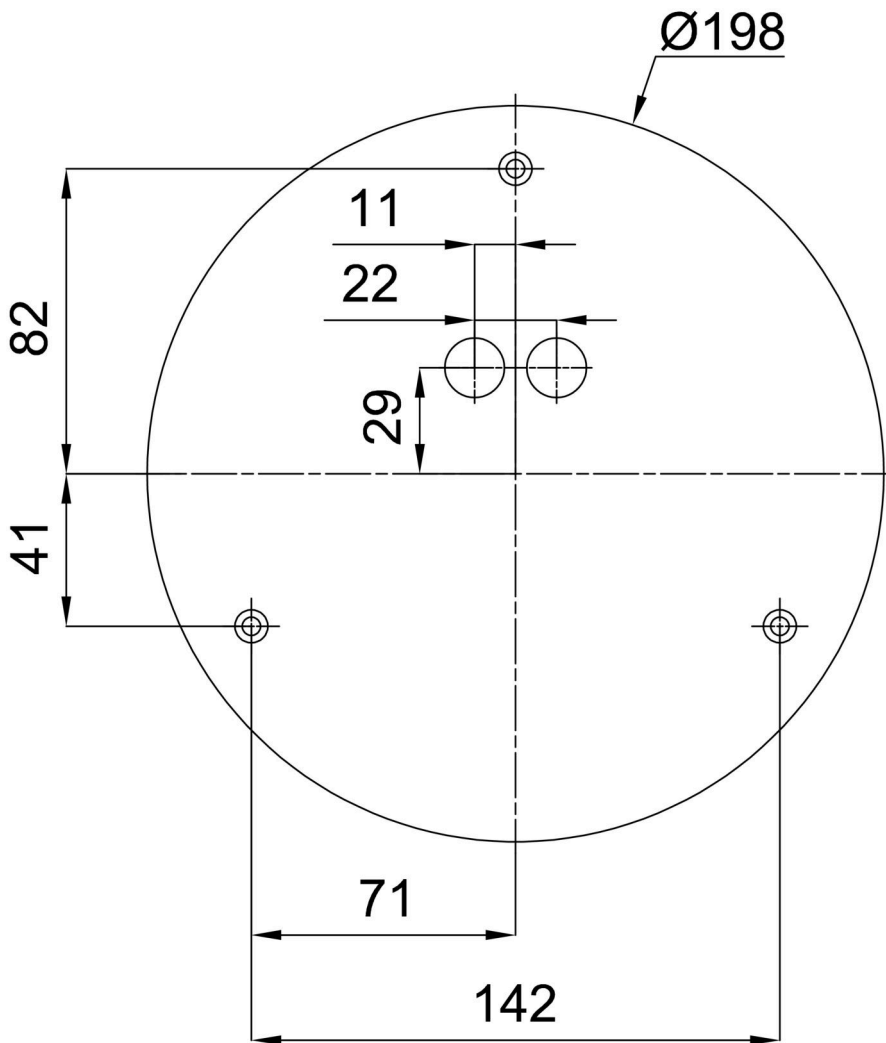

Additional assortment:

Base for surface mounting

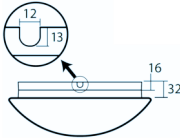
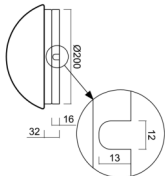
Product code	Name	Color	Description	Picture	Drawing
33500	KN3,B12/B P B	white Ral9003			

Lampshade

Product code	Name	Color	Description	Picture	Drawing
20565	PC21C	white - black		