



DELIA 3

LED-1L20E1050KN94/PM24 DALI 4K##

WWW.OSMONT.CZ

DELIA 3

Product code: DEL67729

Type: LED-1L20E1050KN94/PM24 DALI 4K##

Short description of the luminaire: White surface-mounted LED light DALI and PMMA shade.

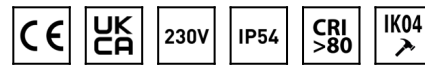

Technical

| | |
|------------------------------|------------------------------|
| Types of luminaires | Dimmable |
| Mounting type | surface mounted |
| Base material | steel |
| Shade material | opal polymethyl methacrylate |
| Base color | white Ra9003 |
| Shade color | white |
| Holding the shade | folding system |
| Mounting location | ceiling/wall |
| Width | 500 mm |
| Length | 500 mm |
| Height | 85 mm |
| Diameter | ø 500 mm |
| mounting holes (diameter) | 3xø5mm |
| Installation wire (diameter) | 2xø16mm |
| Energy Class | D |
| Impact strength | IK04 |
| Operating temperature | from -20°C to +30°C |

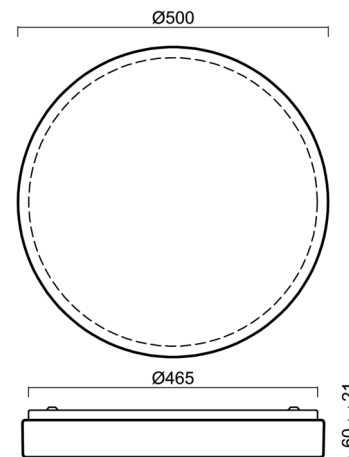

Electric

| | |
|-------------------------------------|---------------------|
| Power consumption | 48 W |
| Ingress Protection | IP54 |
| Socket | LED modul |
| terminal block | snap terminal block |
| Automatic circuit breaker type B10A | 13 pcs |
| Automatic circuit breaker type B16A | 21 pcs |
| Automatic circuit breaker type C10A | 21 pcs |
| Automatic circuit breaker type C16A | 35 pcs |

Luminous

| | |
|-----------------------------|--------------|
| Lum. flux of luminaire | 5330 lm |
| Lum. flux of light source | 8070 lm |
| Luminaire efficacy | 111 lm/W |
| Temperature | 4000 K |
| Rated life time LED L80/B10 | 100000 hours |
| CRI | Ra80 |
| MacAdam | 3 |
| Blue light hazard | Risk group 0 |

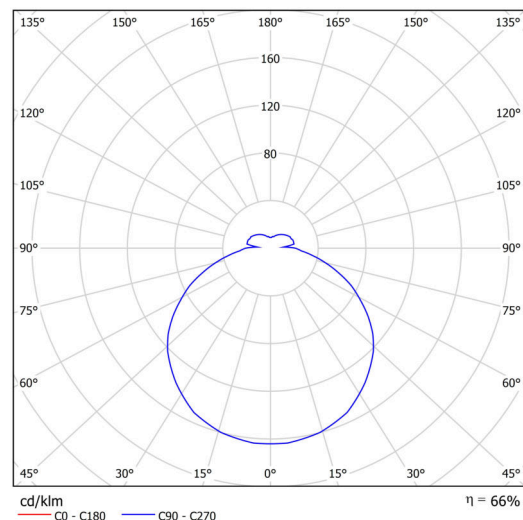

Eulum data for calculation programs are available at www.osmont.cz.

Logistic

| | |
|-------------------|----------------------|
| EAN | 8591728075873 |
| Weight NTTO | 2.6 Kg |
| Weight BTTO | 3 Kg |
| Number of cartons | 1 pcs |
| Package volume | 0.023 m ³ |
| Package 1 width | 0.51 m |
| Package 1 length | 0.51 m |
| Package 1 height | 0.09 m |
| Warranty* | 60 months |

*The warranty for the batteries is valid for 12 months from the date of purchase.

Installation dimensions:

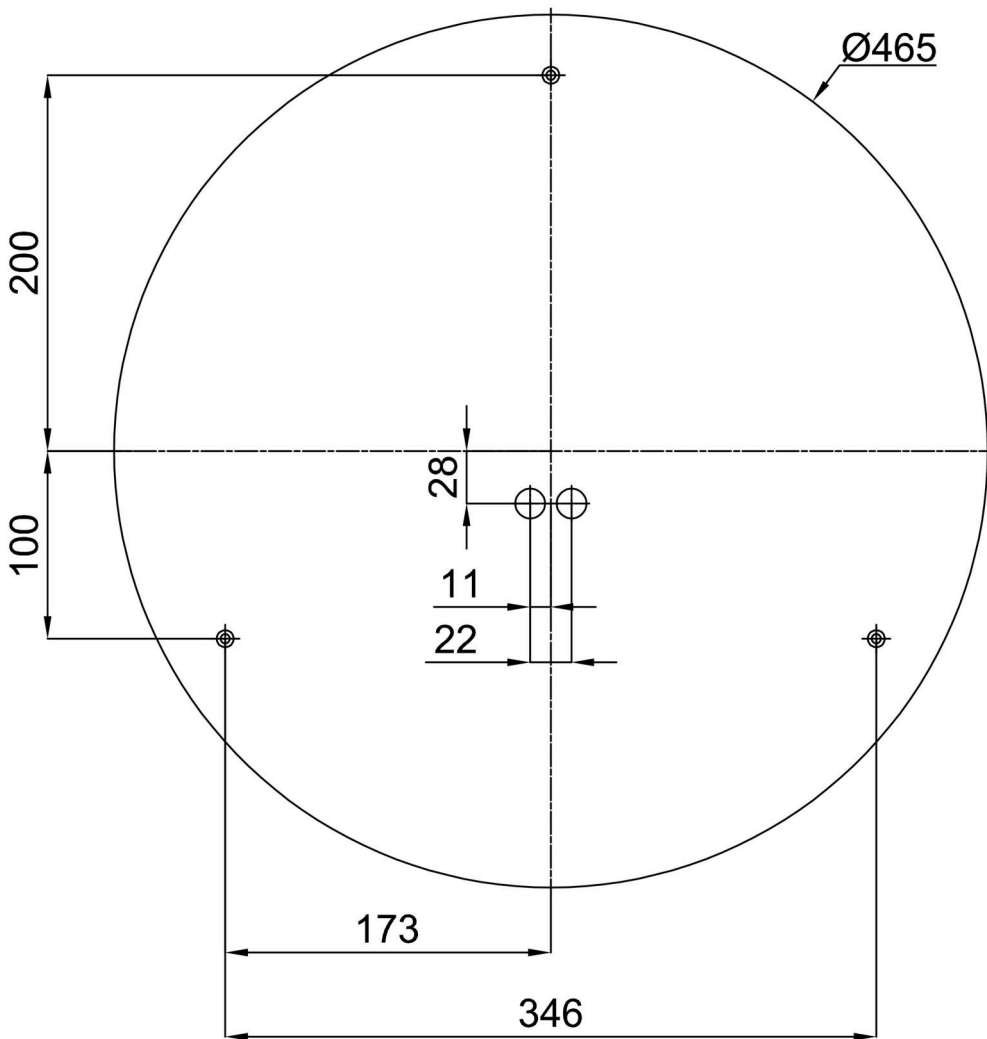

Additional assortment:

Base for surface mounting

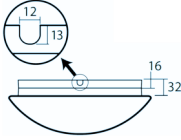
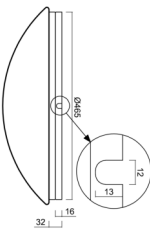
| Product code | Name | Color | Description | Picture | Drawing |
|--------------|----------------|------------------|-------------|--|---|
| 33503 | KN9,K9,B17 /BP | white Ral9003 | |  |  |

Lampshade

| Product code | Name | Color | Description | Picture | Drawing |
|--------------|------|-------|-------------|---|---------|
| 20523 | PM24 | white | |  | |