



DELIA 2A

LED-1L17E700KN73/PC19 HF CORR 4K#

WWW.OSMONT.CZ

DELIA 2A

Product code: DEL73511

Type: LED-1L17E700KN73/PC19 HF CORR 4K#

Short description of the luminaire: White color | surface-mounted LED light | CORRIDOR function (HF+DALI) | polycarbonate shade



Technical

Types of luminaires	Corridor
Mounting type	surface mounted
Base material	steel
Shade material	opal polycarbonate
Base color	white Ral9003
Shade color	white
Holding the shade	folding system
Mounting location	ceiling/wall
Width	360 mm
Length	360 mm
Height	71 mm
Diameter	ø 360 mm
mounting holes (diameter)	3xø5mm
Installation wire (diameter)	2xø16mm
Energy Class	D
Impact strength	IK10

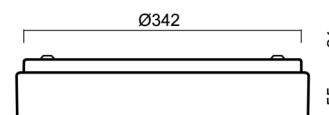
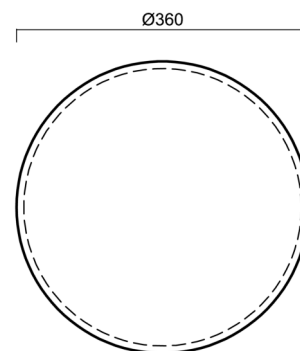

Electric

Power consumption	25 W
Ingress Protection	IP54
Socket	LED modul
Sensor	HF
terminal block	snap terminal block
Automatic circuit breaker type B10A	18 pcs
Automatic circuit breaker type B16A	28 pcs
Automatic circuit breaker type C10A	30 pcs
Automatic circuit breaker type C16A	46 pcs

Luminous

Lum. flux of luminaire	2550 lm
Lum. flux of light source	3930 lm
Luminaire efficacy	102 lm/W
Temperature	4000 K
Rated life time LED L80/B10	100000 hours
CRI	Ra80
MacAdam	3
Blue light hazard	Risk group 0

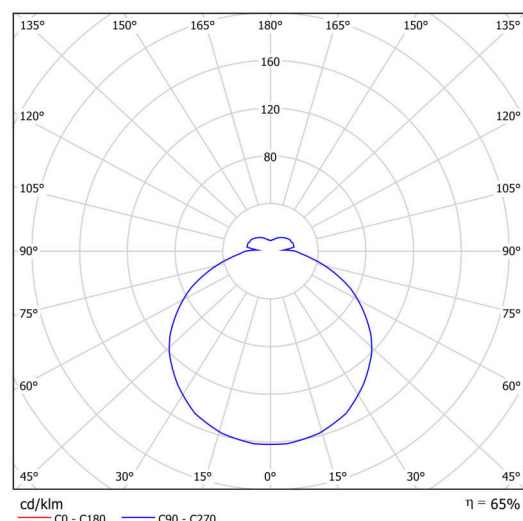

Eulum data for calculation programs are available at www.osmont.cz.

Logistic

EAN	8591728080280
Weight NTTO	1.45 Kg
Weight BTTO	1.85 Kg
Number of cartons	1 pcs
Package volume	0.019 m ³
Package 1 width	0.385 m
Package 1 length	0.37 m
Package 1 height	0.13 m
Warranty*	60 months

*The warranty for the batteries is valid for 12 months from the date of purchase.

Installation dimensions:

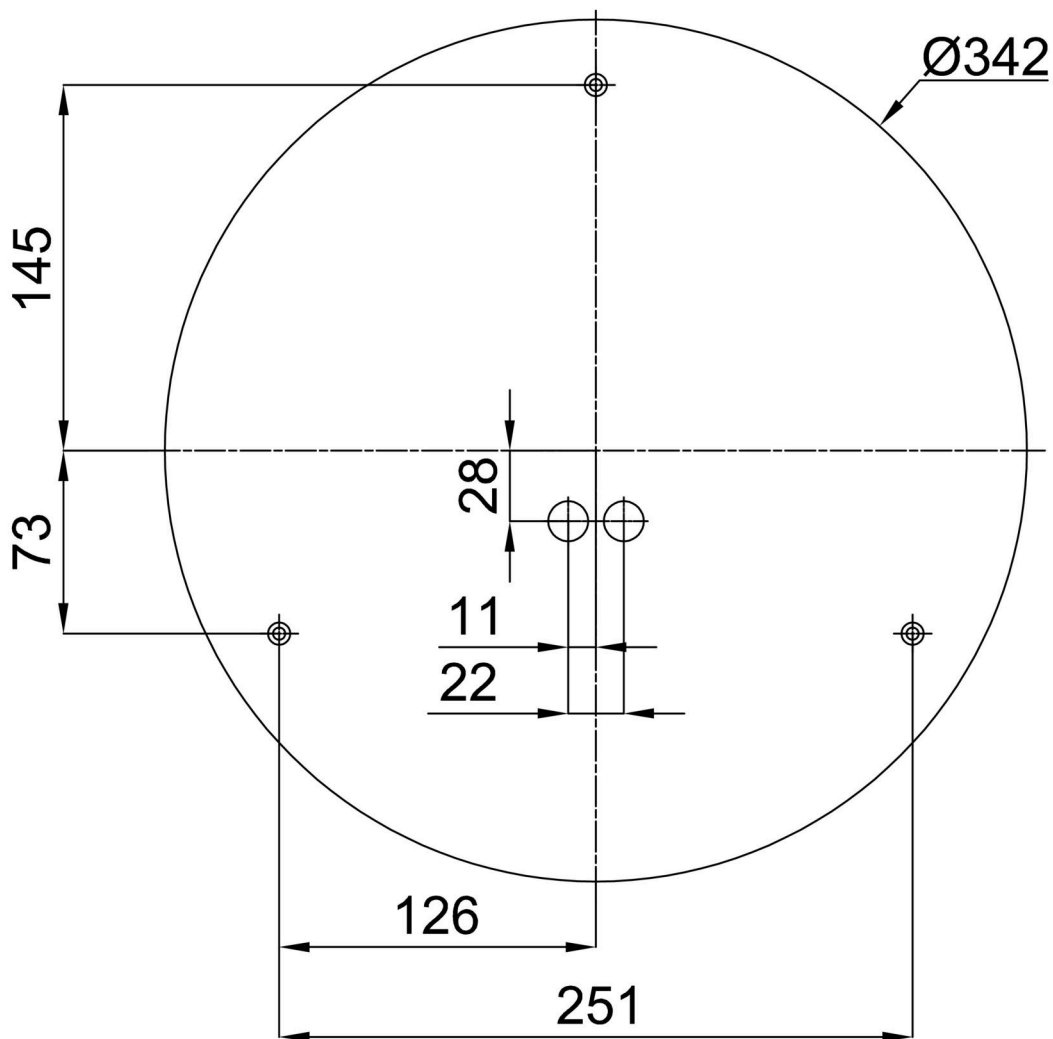

Additional assortment:

Lampshade

Product code	Name	Color	Description	Picture	Drawing
20560	PC19	white		