



DELIA 1A

LED-1L12E500KN32/PC21 4K#

WWW.OSMONT.CZ

DELIA 1A

Product code: DEL56780

Type: LED-1L12E500KN32/PC21 4K#

Short description of the luminaire: White surface-mounted LED light ON/OFF and polycarbonate shade.

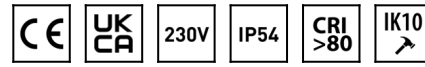

Technical

Types of luminaires	Classic on/off
Mounting type	surface mounted
Base material	steel
Shade material	opal polycarbonate
Base color	white Ra9003
Shade color	white
Holding the shade	folding system
Mounting location	ceiling/wall
Width	220 mm
Length	220 mm
Height	70 mm
Diameter	ø 220 mm
mounting holes (diameter)	3xø5mm
Installation wire (diameter)	2xø16mm
Energy Class	D
Impact strength	IK10
Operating temperature	from -20°C to +30°C

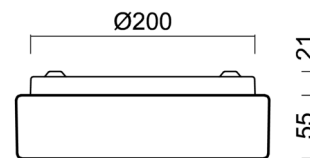
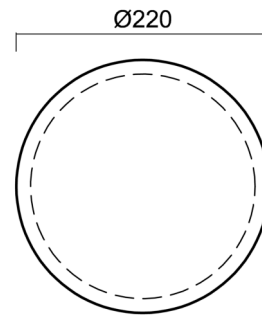

Electric

Power consumption	7 W
Ingress Protection	IP54
Socket	LED modul
terminal block	snap terminal block
Automatic circuit breaker type B10A	50 pcs
Automatic circuit breaker type B16A	78 pcs
Automatic circuit breaker type C10A	84 pcs
Automatic circuit breaker type C16A	130 pcs

Luminous

Lum. flux of luminaire	770 lm
Lum. flux of light source	1040 lm
Luminaire efficacy	110 lm/W
Temperature	4000 K
Rated life time LED L80/B10	100000 hours
CRI	Ra80
MacAdam	3
Blue light hazard	Risk group 0

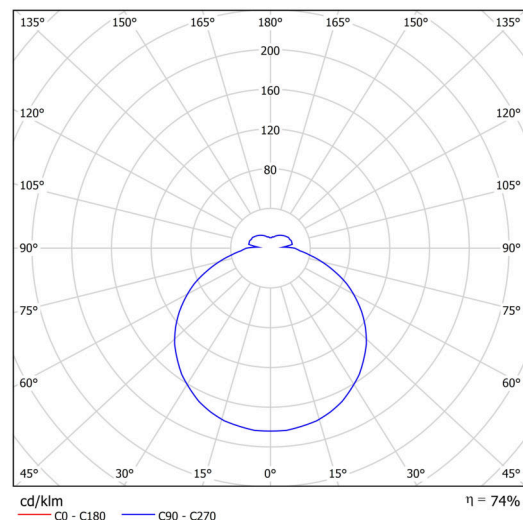

Eulum data for calculation programs are available at www.osmont.cz.

Logistic

EAN	8591728073893
Weight NTTO	0.65 Kg
Weight BTTO	0.75 Kg
Number of cartons	1 pcs
Package volume	0.005 m ³
Package 1 width	0.25 m
Package 1 length	0.23 m
Package 1 height	0.09 m
Warranty*	60 months

*The warranty for the batteries is valid for 12 months from the date of purchase.

Installation dimensions:

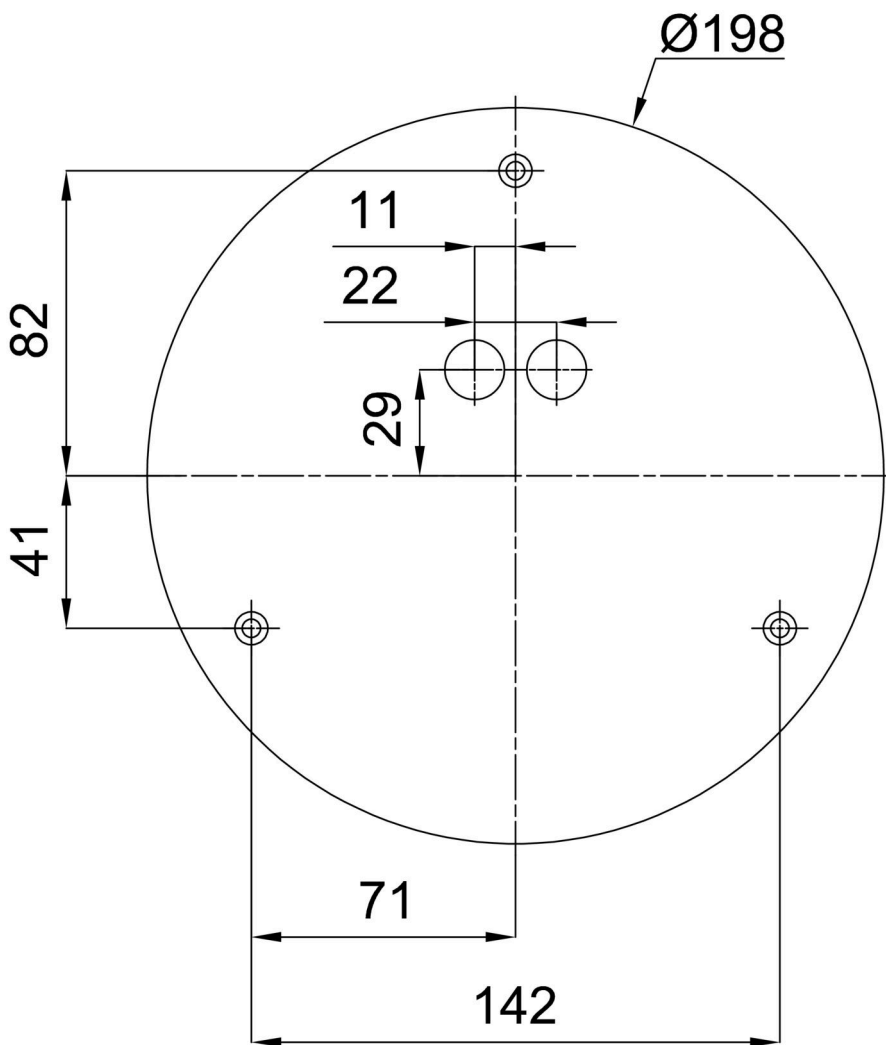

Additional assortment:

Base for surface mounting

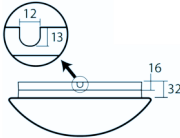
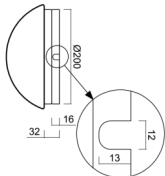
Product code	Name	Color	Description	Picture	Drawing
33500	KN3,B12/B P B	white Ral9003			

Lampshade

Product code	Name	Color	Description	Picture	Drawing
20543	PC21	white		