

## CITADELA LE2

Private: LED-1L20E700ZLEN96/426/L100/SL540C C DALI 3K##

[WWW.OSMONT.CZ](http://WWW.OSMONT.CZ)

# CITADELA LE2

Product code: CIT50029

Type: Private: LED-1L20E700ZLEN96/426/L100/SL540C C DALI 3K##

Short description of the luminaire: Black colour | pendant LED light DALI | TRIPLEX OPAL hand blown glass shade with decorative crystal collar (smoked) | steel wire pendant (SELV, cableless) 100 cm |

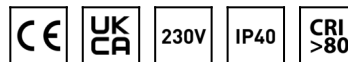

## Technical data

Types of luminaires	Dimmable
Mounting type	Suspended - SELV wire (cableless)
Base material	steel
Shade material	three-layer glass TRIPLEX OPAL
Base color	black Ral9005
Shade color	white
Holding the shade	folding system
Mounting location	ceiling
Width	540 mm
Length	540 mm
Height	70 mm
Diameter	ø 540 mm
Suspension length	1000 mm
mounting holes (diameter)	2xø5mm
Cable entrance	2xø16mm
Impact strength	IK01
Operating temperature	from -20°C to +30°C

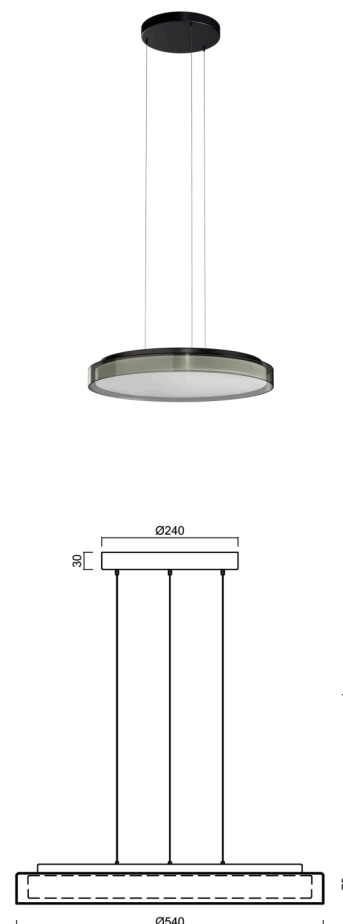

## Electrical data

Power consumption	32 W
Ingress Protection	IP40
Socket	LED modul
terminal block	snap terminal block

## Luminous data

Lum. flux of luminaire	3010 lm
Lum. flux of light source	5330 lm
Chromaticity temperature	3000 K
Rated life time LED L80/B10	100000 hours
CRI	Ra80
MacAdam	3
Blue light hazard	Risk group 0

Eulum data for calculation programs are available at [www.osmont.cz](http://www.osmont.cz).

## Logistical data

EAN	8591728228651
Weight NTTO	5.4 Kg

# TECHNICAL SHEET



Weight BTTO	6.4 Kg
Warranty*	60 months

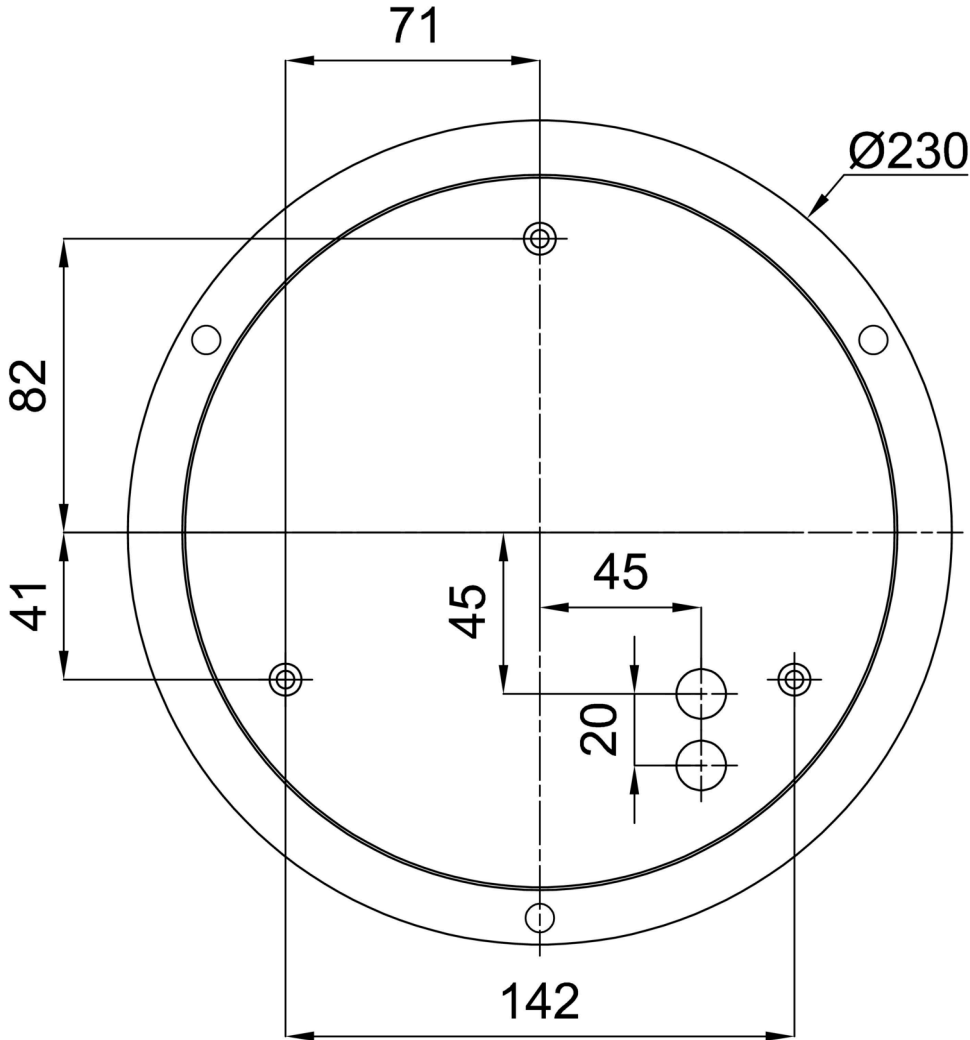

\*The warranty for the batteries is valid for 36 months from the date of purchase.

## Installation dimensions:



Additional assortment:

Decorative collar

Product code	Name	Color	Picture	Drawing
30185	SL540C			
30184	SL540K			
30186	SL540H			

Lampshade

Product code	Name	Color	Picture	Drawing
20116	426	white		