



## CITADELA 2

---

LED-1L20EXMP700KN96/426/SL540C C 3K##

[WWW.OSMONT.CZ](http://WWW.OSMONT.CZ)

# CITADELA 2

Product code: CIT50010

Type: LED-1L20EXMP700KN96/426/SL540C C 3K##

Short description of the luminaire: Black colour | ceiling or wall LED light ON/OFF | multipower driver | TRIPLEX OPAL hand blown glass shade with decorative crystal collar (smoked)



## Technical data

Types of luminaires	Classic on/off
Mounting type	surface mounted
Base material	steel
Shade material	three-layer glass TRIPLEX OPAL
Base color	black Ral9005
Shade color	white
Holding the shade	folding system
Mounting location	ceiling
Width	540 mm
Length	540 mm
Height	70 mm
Diameter	ø 540 mm
mounting holes (diameter)	2xø5mm
Cable entrance	2xø16mm
Energy Class	D
Impact strength	IK01
Operating temperature	from -20°C to +30°C

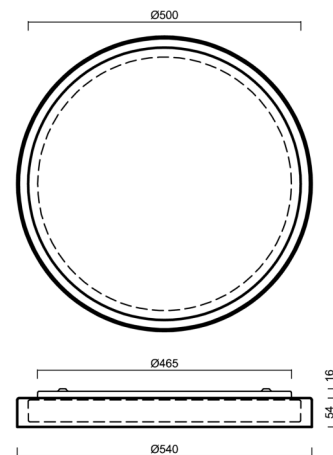

## Electrical data

Power consumption	32 W
Ingress Protection	IP44
Socket	LED modul
terminal block	snap terminal block

## Luminous data

Lum. flux of luminaire	3040 lm
Lum. flux of light source	5370 lm
Chromaticity temperature	3000 K
Rated life time LED L80/B10	100000 hours
CRI	Ra80
MacAdam	3
Blue light hazard	Risk group 0

Eulum data for calculation programs are available at [www.osmont.cz](http://www.osmont.cz).

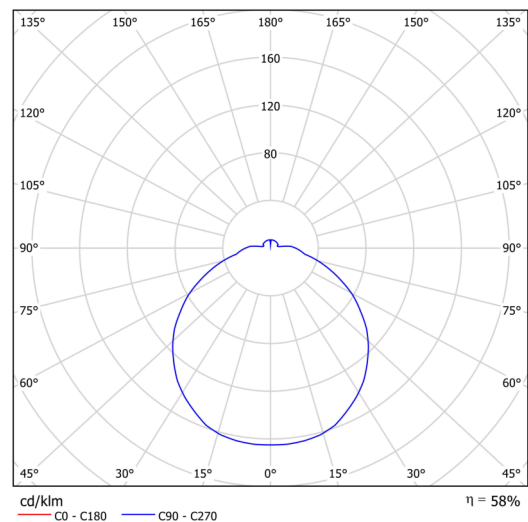

# TECHNICAL SHEET



## Logistical data

EAN	8591728228460
Weight NTTO	4.1 Kg
Weight BTTO	4.3 Kg
Number of cartons	1 pcs
Warranty*	60 months

\*The warranty for the batteries is valid for 36 months from the date of purchase.

## Installation dimensions:

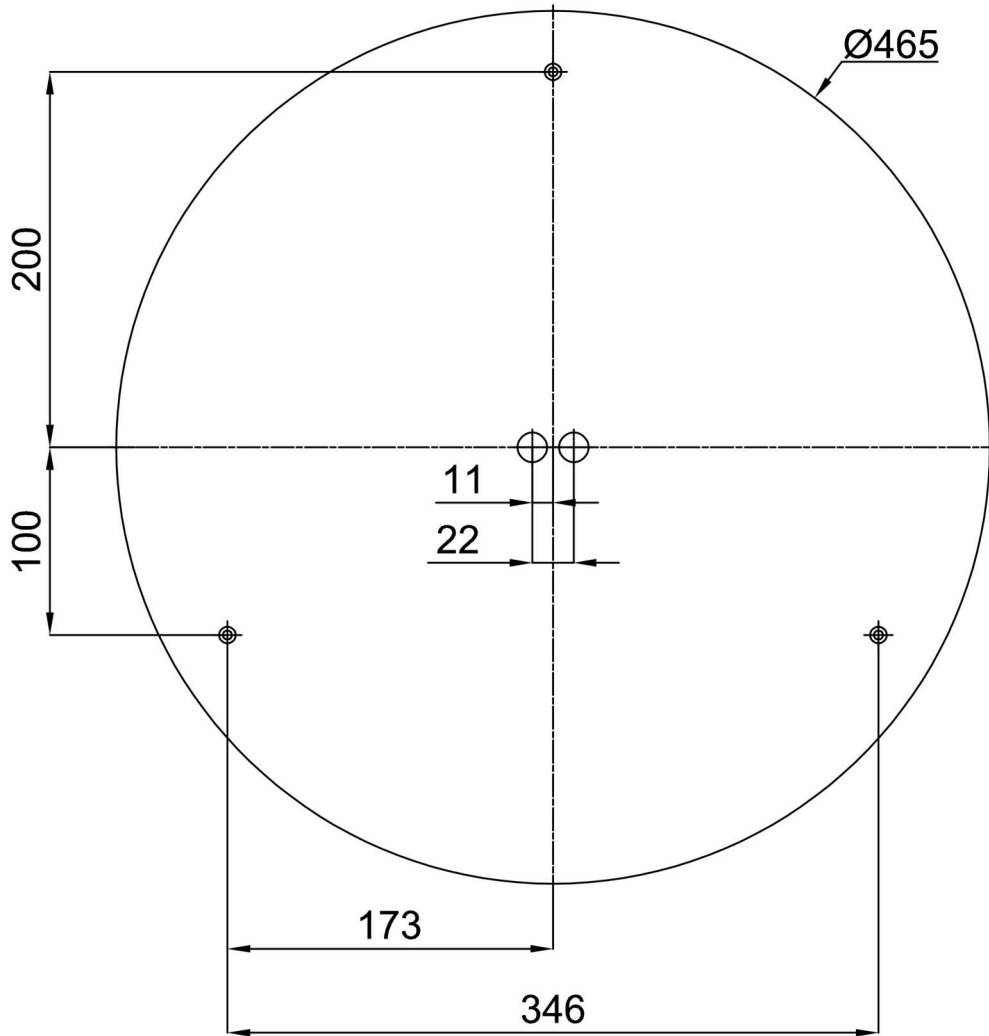

Additional assortment:

Decorative collar

Product code	Name	Color	Picture	Drawing
30186	SL540H			
30185	SL540C			
30184	SL540K			

Lampshade

Product code	Name	Color	Picture	Drawing
20116	426	white		