

CARINA P2

LED-1L20EXMP700ZKN96/426/z5 C 3K##

WWW.OSMONT.CZ

CARINA P2

Product code: CAR60008

Type: LED-1L20EXMP700ZKN96/426/z5 C 3K##

Short description of the luminaire: Black color | pendant LED light | ON/OFF | TRIPLEX OPAL glass shade with matt surface



Technical

Types of luminaires	Classic on/off
Mounting type	Suspended - rod
Base material	steel
Shade material	three-layer glass TRIPLEX OPAL
Base color	black Ral9005
Shade color	white
Holding the shade	folding system
Mounting location	ceiling
Width	500 mm
Length	500 mm
Height	55 mm
Diameter	ø 500 mm
Hinge length	1000 mm
mounting holes (diameter)	2xø5mm
Installation wire (diameter)	2xø16mm
Energy Class	D
Impact strength	IK01

Electric

Power consumption	32 W
Ingress Protection	IP40
Socket	LED modul
terminal block	screw terminal block
Automatic circuit breaker type B10A	37 pcs
Automatic circuit breaker type B16A	59 pcs
Automatic circuit breaker type C10A	37 pcs
Automatic circuit breaker type C16A	59 pcs

Luminous

Lum. flux of luminaire	3490 lm
Lum. flux of light source	5370 lm
Luminaire efficacy	109 lm/W
Temperature	3000 K
Rated life time LED L80/B10	100000 hours
CRI	Ra80
MacAdam	3
Blue light hazard	Risk group 0

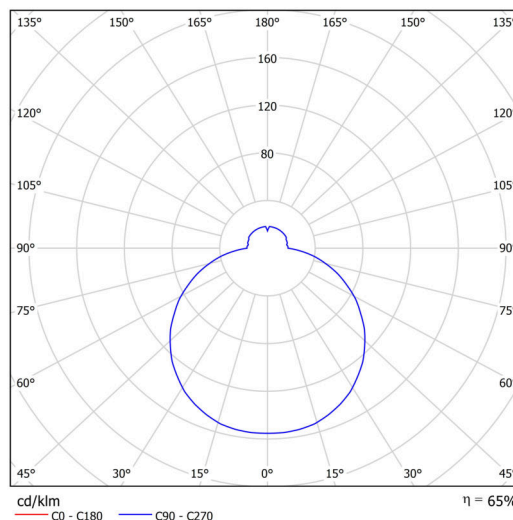
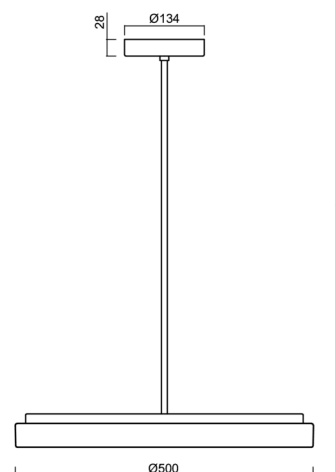
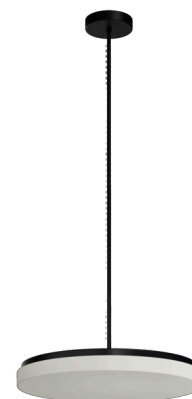

Eulum data for calculation programs are available at www.osmont.cz.

Logistic

EAN	8591728010140
Weight NTTO	5.4 Kg
Weight BTTO	6.4 Kg
Number of cartons	1 pcs
Warranty*	60 months

*The warranty for the batteries is valid for 12 months from the date of purchase.

Installation dimensions:

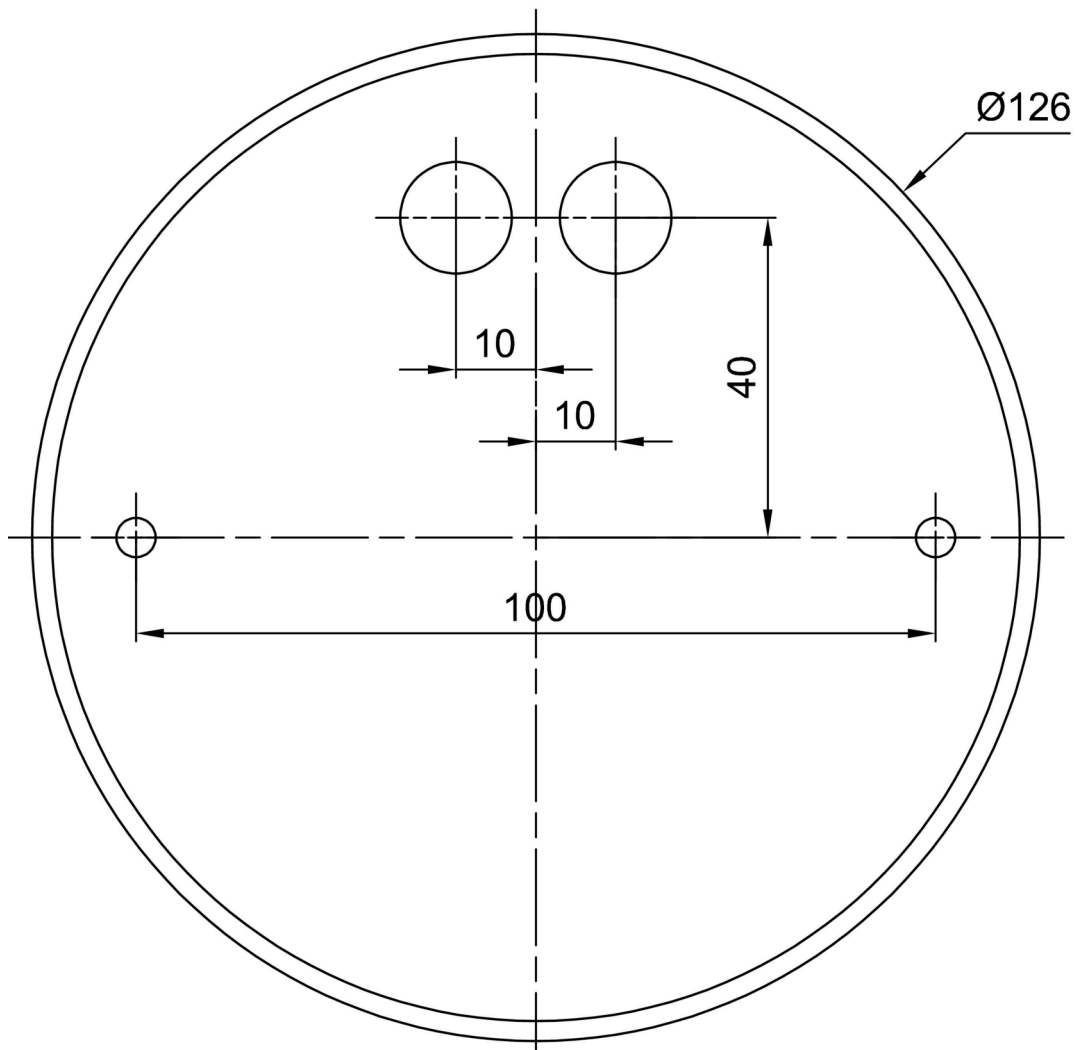

Additional assortment:

Lampshade

Product code	Name	Color	Description	Picture	Drawing
20116	426	white		