



BIANCA 2

IN-12BD1/SL/193 CR*

WWW.OSMONT.CZ

BIANCA 2

Product code: BIA50536

Type: IN-12BD1/SL/193 CR*

Short description of the luminaire: Chrome table E27 light ON/OFF with TRIPLEX OPAL glass shade.



Technical

Types of luminaires	Classic on/off
Mounting type	table lamps
Base material	polycarbonate
Shade material	three-layer glass TRIPLEX OPAL
Base color	chrome
Shade color	white
Holding the shade	bayonet
Mounting location	table
Width	250 mm
Length	250 mm
Height	240 mm
Diameter	ø 250 mm
mounting holes (diameter)	4xø5mm
Installation wire (diameter)	2xø16mm
Impact strength	IK01
Operating temperature	from -20°C to +30°C

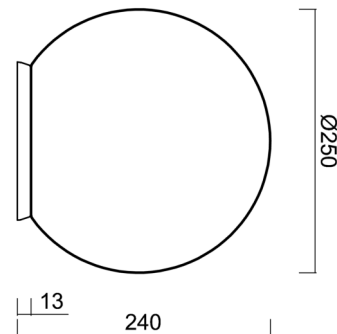

Electric

Voltage type	AC
AC voltage	220 - 240 V
Power consumption	25 W
Ingress Protection	IP40
Socket	E27
terminal block	screw terminal block

Luminous

Blue light hazard	Risk group 0
-------------------	--------------

Eulum data for calculation programs are available at www.osmont.cz.



Logistic

EAN	8591728505363
Weight NTTO	1.7 Kg
Weight BTTO	2.1 Kg
Number of cartons	1 pcs
Package volume	0.017 m ³
Package 1 width	0.26 m
Package 1 length	0.26 m
Package 1 height	0.255 m
Warranty*	60 months

*The warranty for the batteries is valid for 12 months from the date of purchase.

Installation dimensions:



Additional assortment:

Base for surface mounting

Product code	Name	Color	Description	Picture	Drawing
33521	BD1/BP 2-1	white Ral9003			

Lampshade

Product code	Name	Color	Description	Picture	Drawing
20093	193	white		