



AURA V11

LED-1L16E350BTV15/015 HF CORR 3K#

WWW.OSMONT.CZ

AURA V11

Product code: AUR68110

Type: LED-1L16E350BTV15/015 HF CORR 3K#

Short description of the luminaire: White semi-recessed LED light with CORRIDOR function with TRIPLEX OPAL glass shade.

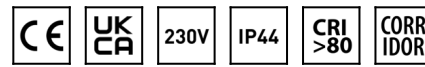

Technical

Types of luminaires	Corridor
Mounting type	semi-recessed
Base material	steel
Shade material	three-layer glass TRIPLEX OPAL
Base color	white Ral9003
Shade color	white
Holding the shade	bayonet
Mounting location	ceiling/wall
Width	420 mm
Length	420 mm
Height	104 mm
Diameter	ø 420 mm
mounting holes (diameter)	none
Installation wire (diameter)	2xø16mm
Energy Class	D
Impact strength	IK01
Operating temperature	from -20°C to +30°C

Electric

Power consumption	17 W
Ingress Protection	IP44
Socket	LED modul
Sensor	HF
terminal block	snap terminal block
Automatic circuit breaker type B10A	18 pcs
Automatic circuit breaker type B16A	28 pcs
Automatic circuit breaker type C10A	30 pcs
Automatic circuit breaker type C16A	46 pcs

Luminous

Lum. flux of luminaire	1730 lm
Lum. flux of light source	2660 lm
Luminaire efficacy	101 lm/W
Temperature	3000 K
Rated life time LED L80/B10	100000 hours
CRI	Ra80
MacAdam	3
Blue light hazard	Risk group 0

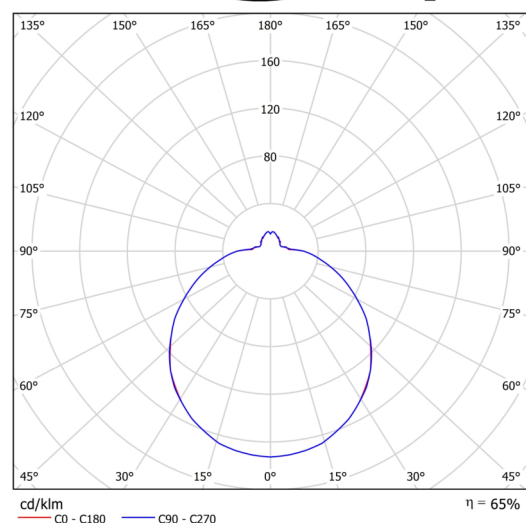
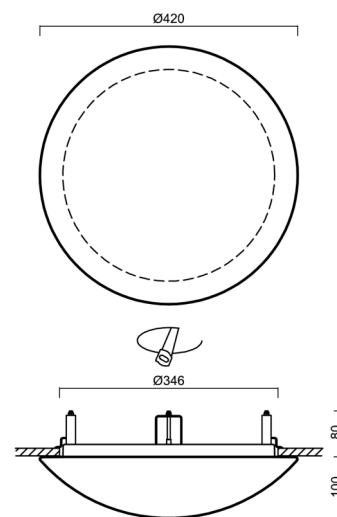

Eulum data for calculation programs are available at www.osmont.cz.

Logistic

EAN	8591728069957
Weight NTTO	3.4 Kg
Weight BTTO	3.8 Kg
Number of cartons	1 pcs
Package volume	0.033 m ³
Package 1 width	0.43 m
Package 1 length	0.43 m
Package 1 height	0.18 m
Warranty*	60 months

*The warranty for the batteries is valid for 12 months from the date of purchase.

Installation dimensions:

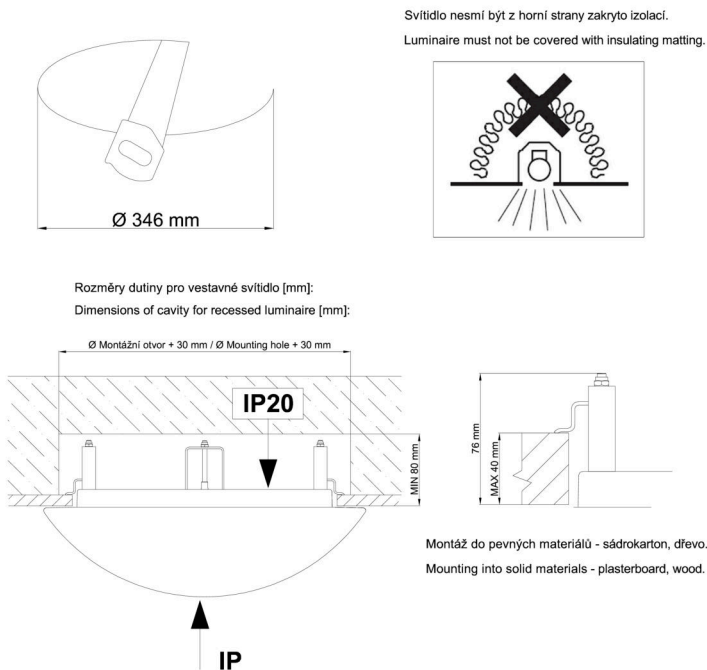

Additional assortment:

Lampshade

Product code	Name	Color	Description	Picture	Drawing
20056	015	white		