

AURA P4

IN-22ZK74/072/z1*

WWW.OSMONT.CZ

AURA P4

Product code: AUR54011

Type: IN-22ZK74/072/z1*

Short description of the luminaire: White pendant E27 light ON/OFF with TRIPLEX OPAL glass shade.



Technical

Types of luminaires	Classic on/off
Mounting type	Suspended - rod
Base material	steel
Shade material	three-layer glass TRIPLEX OPAL
Base color	white Ral9003
Shade color	white
Holding the shade	folding system
Mounting location	ceiling
Width	420 mm
Length	420 mm
Height	135 mm
Diameter	ø 420 mm
Hinge length	200 mm
mounting holes (diameter)	2xø5mm
Installation wire (diameter)	2xø16mm
Impact strength	IK01
Operating temperature	from -20°C to +30°C

Electric

Voltage type	AC
AC voltage	220 - 240 V
Power consumption	2x25 W
Ingress Protection	IP40
Socket	E27
terminal block	screw terminal block

Luminous

Blue light hazard	Risk group 0
-------------------	--------------

Eulum data for calculation programs are available at www.osmont.cz.

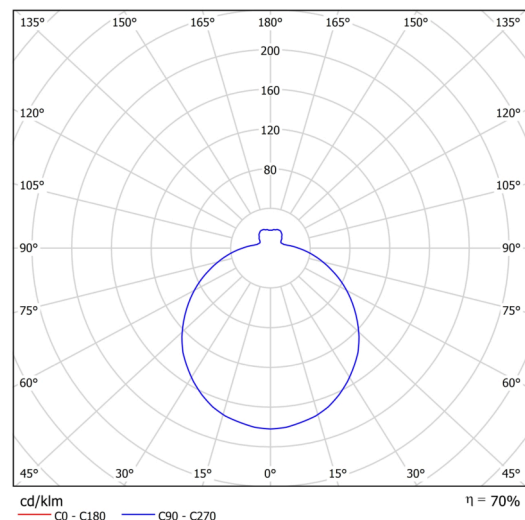
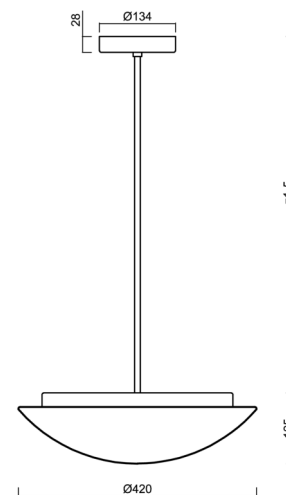

Logistic

EAN	8591728540111
Weight NTTO	5.1 Kg
Weight BTTO	6.9 Kg
Number of cartons	2 pcs
Package volume	0.035 m ³
Package 1 width	0.435 m
Package 1 length	0.435 m
Package 1 height	0.13 m
Warranty*	60 months

*The warranty for the batteries is valid for 12 months from the date of purchase.

Installation dimensions:

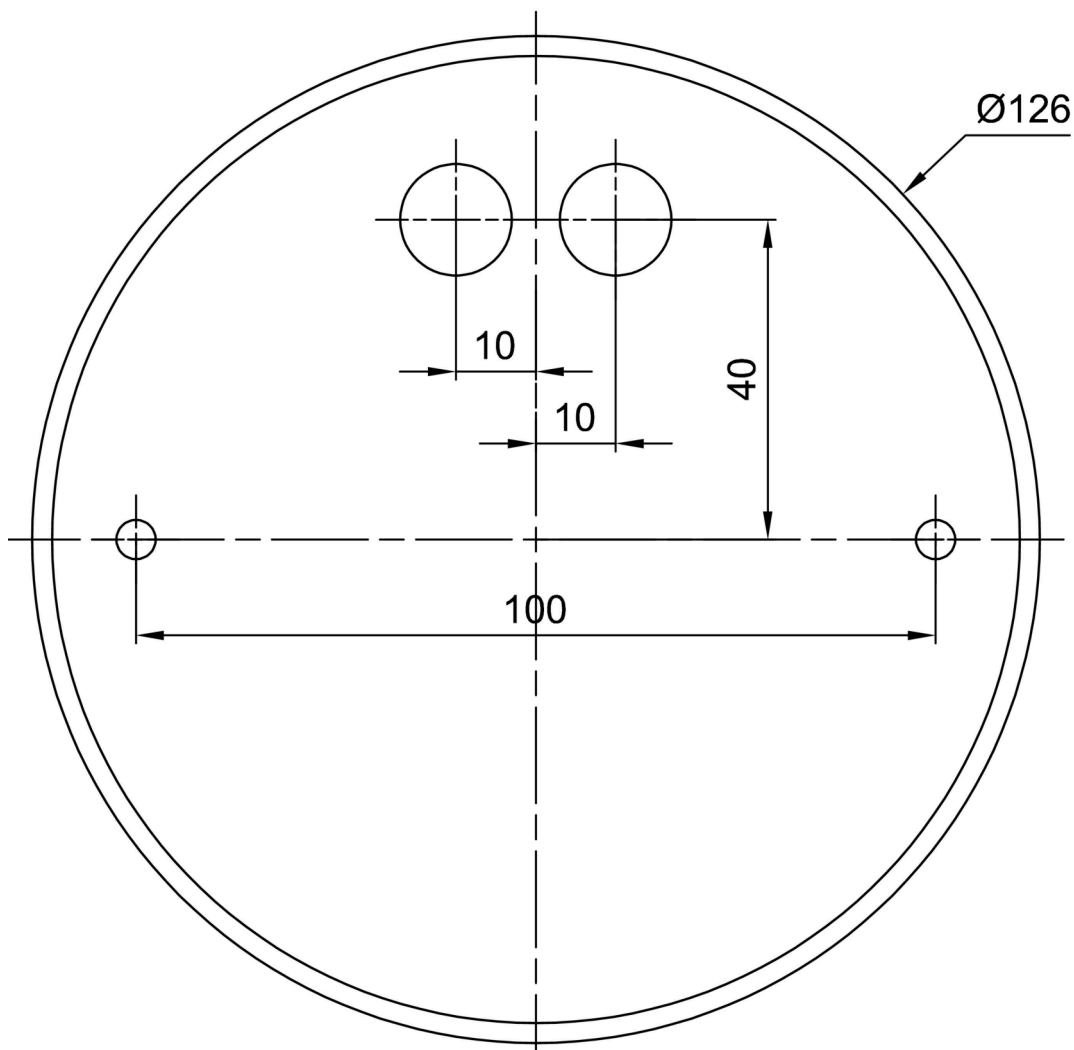

Additional assortment:

Lampshade

Product code	Name	Color	Description	Picture	Drawing
20004	072	white		