



AURA 2

LED-1L18E250K53/042 4K#

WWW.OSMONT.CZ

AURA 2

Product code: AUR71500

Type: LED-1L18E250K53/042 4K#

Short description of the luminaire: White surface-mounted LED light ON/OFF with TRIPLEX OPAL glass shade

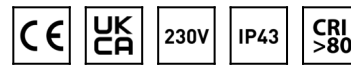

Technical

Types of luminaires	Classic on/off
Mounting type	surface mounted
Base material	steel
Shade material	three-layer glass TRIPLEX OPAL
Base color	white Ral9003
Shade color	white
Holding the shade	folding system
Mounting location	ceiling/wall
Width	280 mm
Length	280 mm
Height	120 mm
Diameter	ø 280 mm
mounting holes (diameter)	4xø5mm
Installation wire (diameter)	2xø16mm
Energy Class	D
Impact strength	IK01
Operating temperature	from -20°C to +30°C

Electric

Power consumption	11 W
Ingress Protection	IP43
Socket	LED modul
terminal block	snap terminal block
Automatic circuit breaker type B10A	72 pcs
Automatic circuit breaker type B16A	116 pcs
Automatic circuit breaker type C10A	72 pcs
Automatic circuit breaker type C16A	116 pcs

Luminous

Lum. flux of luminaire	1140 lm
Lum. flux of light source	1680 lm
Luminaire efficacy	103 lm/W
Temperature	4000 K
Rated life time LED L80/B10	100000 hours
CRI	Ra80
MacAdam	3
Blue light hazard	Risk group 0

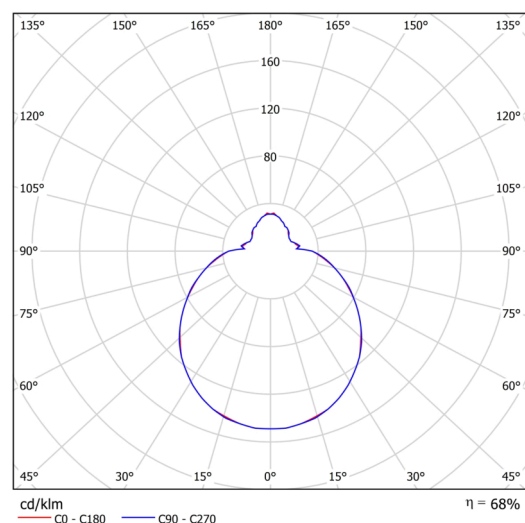
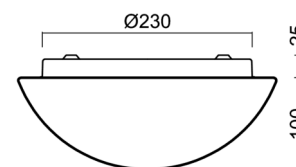
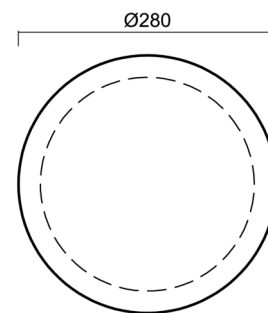

Eulum data for calculation programs are available at www.osmont.cz.

Logistic

EAN	8591728072018
Weight NTTO	1.7 Kg
Weight BTTO	1.9 Kg
Number of cartons	1 pcs
Package volume	0.011 m ³
Package 1 width	0.3 m
Package 1 length	0.285 m
Package 1 height	0.13 m
Warranty*	60 months

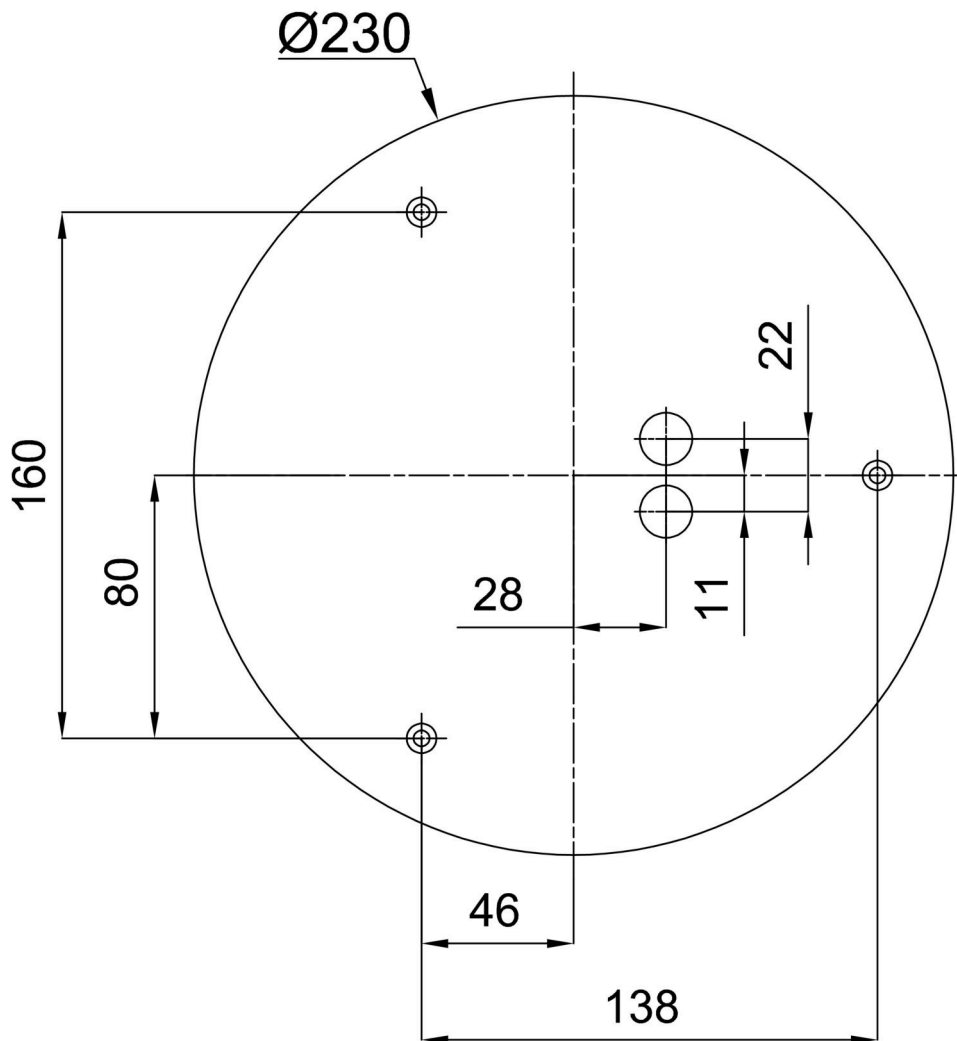

*The warranty for the batteries is valid for 12 months from the date of purchase.

Installation dimensions:



Additional assortment:

Decorative collar

Product code	Name	Color	Description	Picture	Drawing
30123	K52/DL4	white Ra19003	the collar is held by the base		
30124	K52/DL14	polished stainless steel	the collar is held by the base		
30125	K52/DL15	brushed stainless steel	the collar is held by the base		

Lampshade

Product code	Name	Color	Description	Picture	Drawing
20002	042	white		