



AURA 11

LED-1L16E350BT15/015 HF CORR 4K#

WWW.OSMONT.CZ

AURA 11

Product code: AUR68550

Type: LED-1L16E350BT15/015 HF CORR 4K#

Short description of the luminaire: White surface-mounted LED light with CORRIDOR function with TRIPLEX OPAL glass shade.

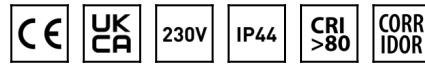

Technical

Types of luminaires	Corridor
Mounting type	surface mounted
Base material	steel
Shade material	three-layer glass TRIPLEX OPAL
Base color	white Ral9003
Shade color	white
Holding the shade	bayonet
Mounting location	ceiling/wall
Width	420 mm
Length	420 mm
Height	125 mm
Diameter	ø 420 mm
mounting holes (diameter)	3xø5mm
Installation wire (diameter)	2xø16mm
Energy Class	D
Impact strength	IK01
Operating temperature	from -20°C to +30°C

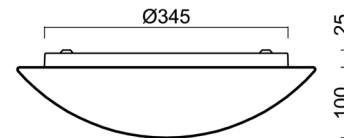
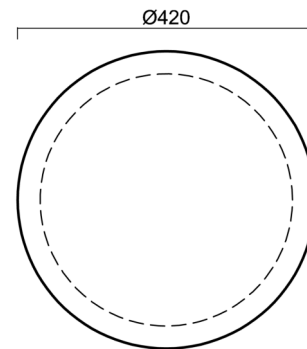

Electric

Power consumption	17 W
Ingress Protection	IP44
Socket	LED modul
Sensor	HF
terminal block	snap terminal block
Automatic circuit breaker type B10A	18 pcs
Automatic circuit breaker type B16A	28 pcs
Automatic circuit breaker type C10A	30 pcs
Automatic circuit breaker type C16A	46 pcs

Luminous

Lum. flux of luminaire	1800 lm
Lum. flux of light source	2770 lm
Luminaire efficacy	105 lm/W
Temperature	4000 K
Rated life time LED L80/B10	100000 hours
CRI	Ra80
MacAdam	3
Blue light hazard	Risk group 0

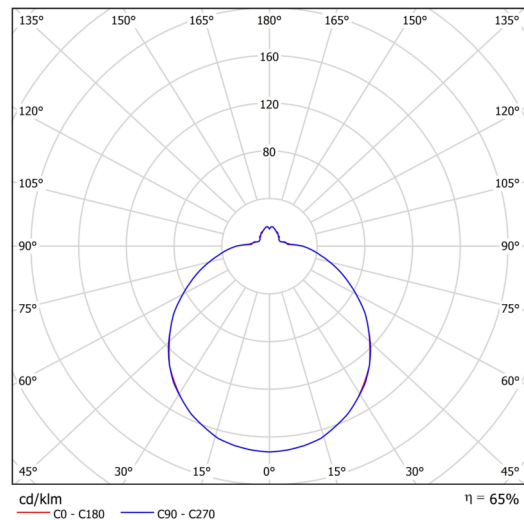

Eulum data for calculation programs are available at

Logistic

EAN	8591728070199
Weight NTTO	3.2 Kg
Weight BTTO	3.6 Kg
Number of cartons	1 pcs
Package volume	0.025 m ³
Package 1 width	0.435 m
Package 1 length	0.435 m
Package 1 height	0.13 m
Warranty*	60 months

*The warranty for the batteries is valid for 12 months from the date of purchase.

Installation dimensions:

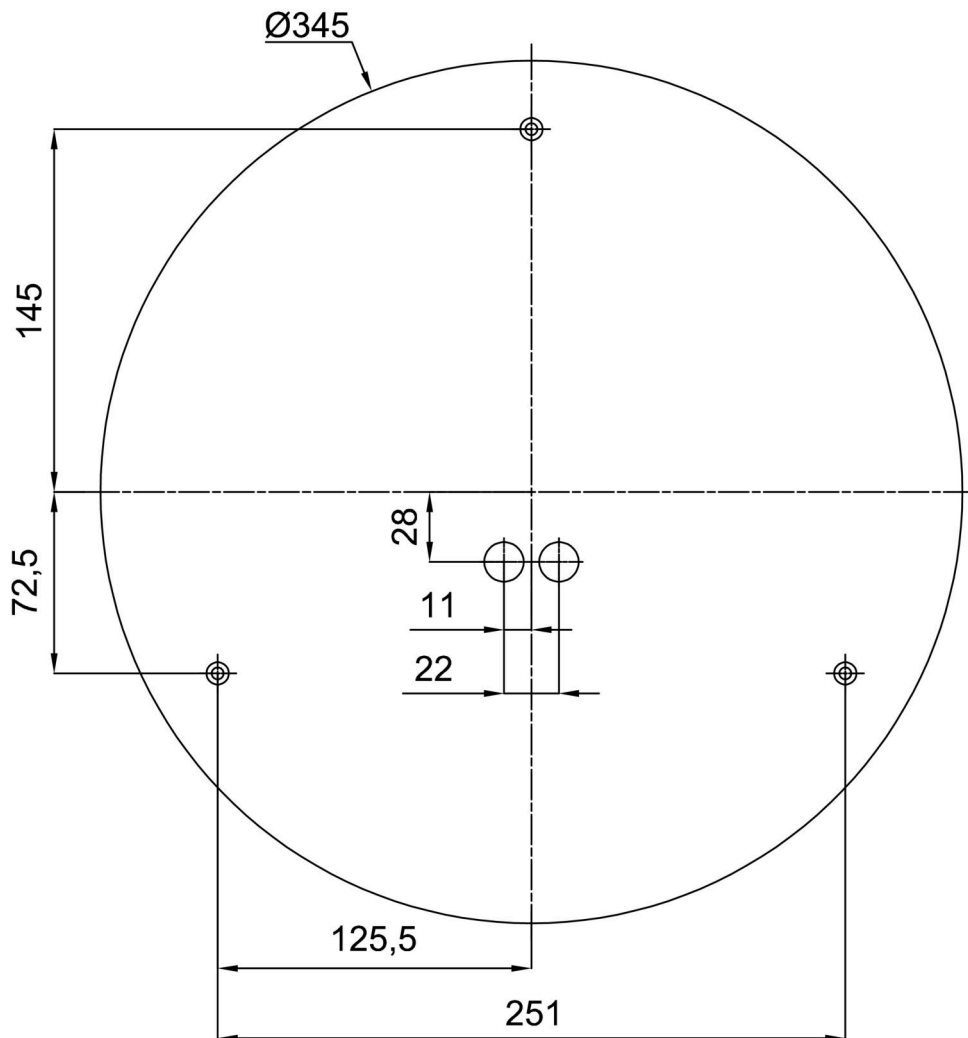

Additional assortment:

Decorative collar

Product code	Name	Color	Description	Picture	Drawing
30140	B15/X14	polished stainless steel	the collar is held by the shade		
30139	B15/X4	white Ral9003	the collar is held by the shade		
30142	B15/X13	grey	the collar is held by the shade		
30141	B15/X12	polished brass	the collar is held by the shade		

Base for surface mounting

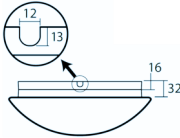
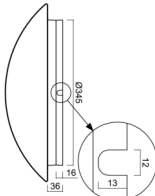
Product code	Name	Color	Description	Picture	Drawing
33506	B15/BP	white Ral9003			

Lampshade

Product code	Name	Color	Description	Picture	Drawing
20056	015	white		