



AURA 10 IP

LED-1L15E350BD14/014 HF CORR 4K#

WWW.OSMONT.CZ

AURA 10 IP

Product code: AUR70875

Type: LED-1L15E350BD14/014 HF CORR 4K#

Short description of the luminaire: White surface-mounted LED light with CORRIDOR function with TRIPLEX OPAL glass shade

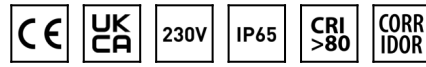

Technical

Types of luminaires	Corridor
Mounting type	surface mounted
Base material	polypropylene composite
Shade material	three-layer glass TRIPLEX OPAL
Base color	white Ral9003
Shade color	white
Holding the shade	bayonet
Mounting location	ceiling/wall
Width	360 mm
Length	360 mm
Height	126 mm
Diameter	ø 360 mm
mounting holes (diameter)	3xø5mm
Installation wire (diameter)	2xø16mm
Energy Class	D
Impact strength	IK01
Operating temperature	from -20°C to +30°C

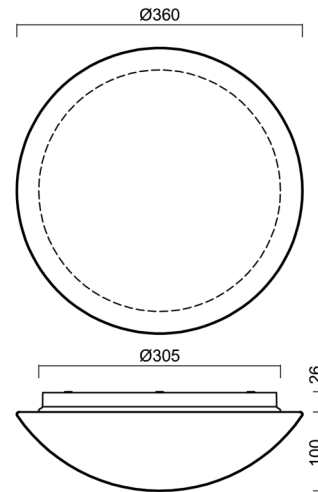

Electric

Power consumption	13 W
Ingress Protection	IP65
Socket	LED modul
Sensor	HF
terminal block	snap terminal block
Automatic circuit breaker type B10A	21 pcs
Automatic circuit breaker type B16A	35 pcs
Automatic circuit breaker type C10A	35 pcs
Automatic circuit breaker type C16A	58 pcs

Luminous

Lum. flux of luminaire	1440 lm
Lum. flux of light source	2220 lm
Luminaire efficacy	110 lm/W
Temperature	4000 K
Rated life time LED L80/B10	100000 hours
CRI	Ra80
MacAdam	3
Blue light hazard	Risk group 0

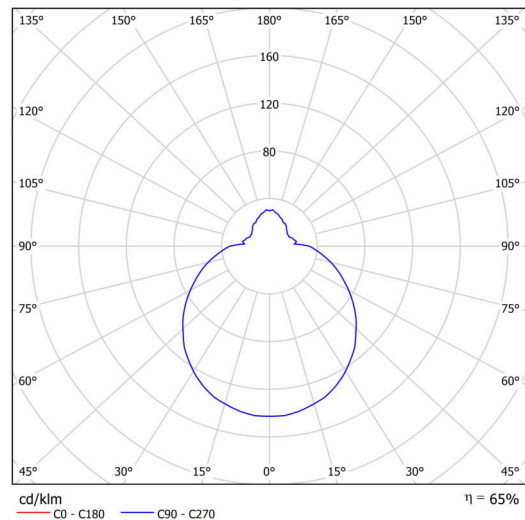

Eulum data for calculation programs are available at www.osmont.cz.

Logistic

EAN	8591728071004
Weight NTTO	2.5 Kg
Weight BTTO	2.8 Kg
Number of cartons	1 pcs
Package volume	0.017 m ³
Package 1 width	0.375 m
Package 1 length	0.355 m
Package 1 height	0.13 m
Warranty*	60 months

*The warranty for the batteries is valid for 12 months from the date of purchase.

Installation dimensions:



Additional assortment:

Decorative collar

Product code	Name	Color	Description	Picture	Drawing
30136	B14/X14	polished stainless steel	the collar is held by the shade		
30135	B14/X4	white Ral9003	the collar is held by the shade		
30138	B14/X13	grey	the collar is held by the shade		
30137	B14/X12	polished brass	the collar is held by the shade		

Lampshade

Product code	Name	Color	Description	Picture	Drawing
20055	014	white		