

ARAKIS LE3

LED-1L16E700ZLE86/417/L100 C DALI 3K#

WWW.OSMONT.CZ

ARAKIS LE3

Product code: ARA67497

Type: LED-1L16E700ZLE86/417/L100 C DALI 3K#

Short description of the luminaire: Black pendant LED light DALI with TRIPLEX OPAL glass shade.

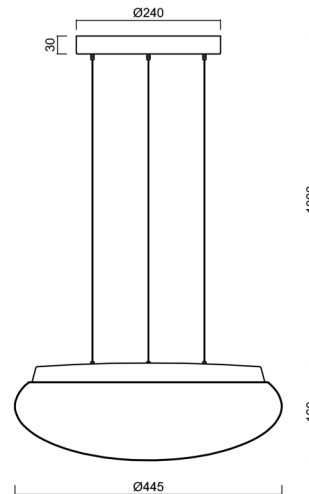
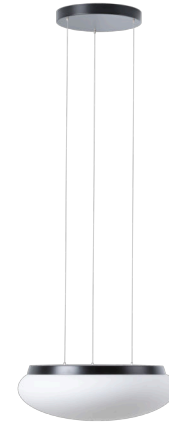

Technical

Types of luminaires	Dimmable
Mounting type	Suspended - SELV wire (cableless)
Base material	steel
Shade material	three-layer glass TRIPLEX OPAL
Base color	black Ral9005
Shade color	white
Holding the shade	folding system
Mounting location	ceiling
Width	445 mm
Length	445 mm
Height	160 mm
Diameter	ø 445 mm
Hinge length	1000 mm
mounting holes (diameter)	3xø5mm
Installation wire (diameter)	2xø16mm
Energy Class	D
Impact strength	IK01
Operating temperature	from -20°C to +30°C

Electric

Power consumption	34 W
Ingress Protection	IP40
Socket	LED modul
terminal block	snap terminal block
Automatic circuit breaker type B10A	31 pcs
Automatic circuit breaker type B16A	50 pcs
Automatic circuit breaker type C10A	52 pcs
Automatic circuit breaker type C16A	85 pcs

Luminous

Lum. flux of luminaire	3330 lm
Lum. flux of light source	5050 lm
Luminaire efficacy	97 lm/W
Temperature	3000 K
Rated life time LED L80/B10	100000 hours
CRI	Ra80
MacAdam	3
Blue light hazard	Risk group 0

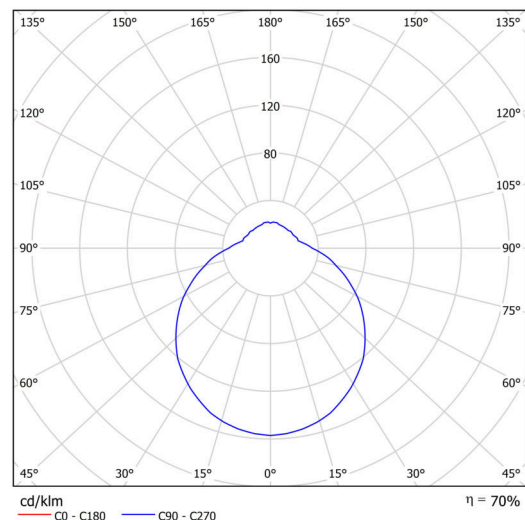

Eulum data for calculation programs are available at

Logistic

EAN	8591728064037
Weight NTTO	5.9 Kg
Weight BTTO	6.5 Kg
Number of cartons	1 pcs
Package volume	0.065 m ³
Package 1 width	0.52 m
Package 1 length	0.52 m
Package 1 height	0.24 m
Warranty*	60 months

*The warranty for the batteries is valid for 12 months from the date of purchase.

Installation dimensions:



Additional assortment:

Lampshade

Product code	Name	Color	Description	Picture	Drawing
20127	417	white		