

ALTAIR 2S

LED-1L35E700US21/421 4K#

WWW.OSMONT.CZ

ALTAIR 2S

Product code: ALT59818

Type: LED-1L35E700US21/421 4K#

Short description of the luminaire: White surface-mounted LED light ON/OFF with TRIPLEX OPAL glass shade.

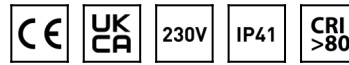

Technical

Types of luminaires	Classic on/off
Mounting type	surface mounted
Base material	steel
Shade material	three-layer glass TRIPLEX OPAL
Base color	white Ral9003
Shade color	white
Holding the shade	folding system
Mounting location	ceiling/wall
Width	390 mm
Length	362 mm
Height	128 mm
mounting holes (diameter)	4xØ5mm
Installation wire (diameter)	2xØ16mm
Energy Class	D
Impact strength	IK01

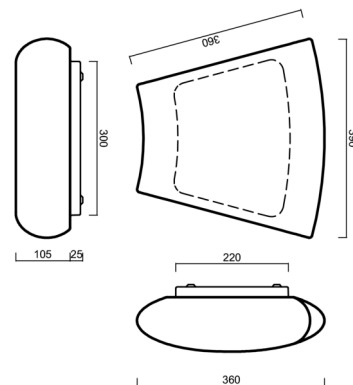

Electric

Power consumption	19 W
Ingress Protection	IP41
Socket	LED modul
terminal block	snap terminal block
Automatic circuit breaker type B10A	31 pcs
Automatic circuit breaker type B16A	50 pcs
Automatic circuit breaker type C10A	52 pcs
Automatic circuit breaker type C16A	85 pcs

Luminous

Lum. flux of luminaire	2450 lm
Lum. flux of light source	3220 lm
Luminaire efficacy	128 lm/W
Temperature	4000 K
Rated life time LED L80/B10	100000 hours
CRI	Ra80
MacAdam	3
Blue light hazard	Risk group 0

Eulum data for calculation programs are available at www.osmont.cz.

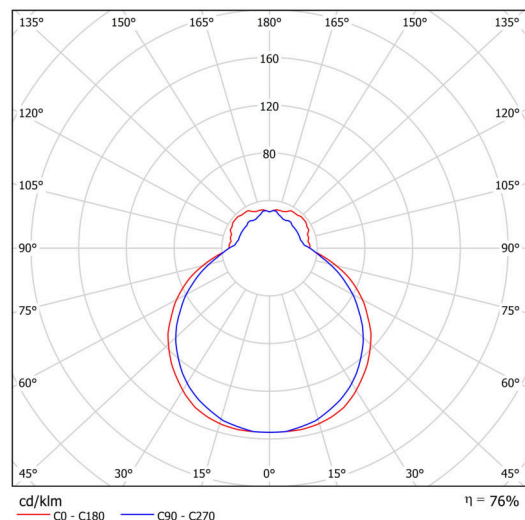

Logistic

EAN	8591728063429
Weight NTTO	4.7 Kg
Weight BTTO	5 Kg
Number of cartons	1 pcs
Package volume	0.018 m ³
Package 1 width	0.365 m
Package 1 length	0.365 m
Package 1 height	0.135 m
Warranty*	60 months

*The warranty for the batteries is valid for 12 months from the date of purchase.

Installation dimensions:

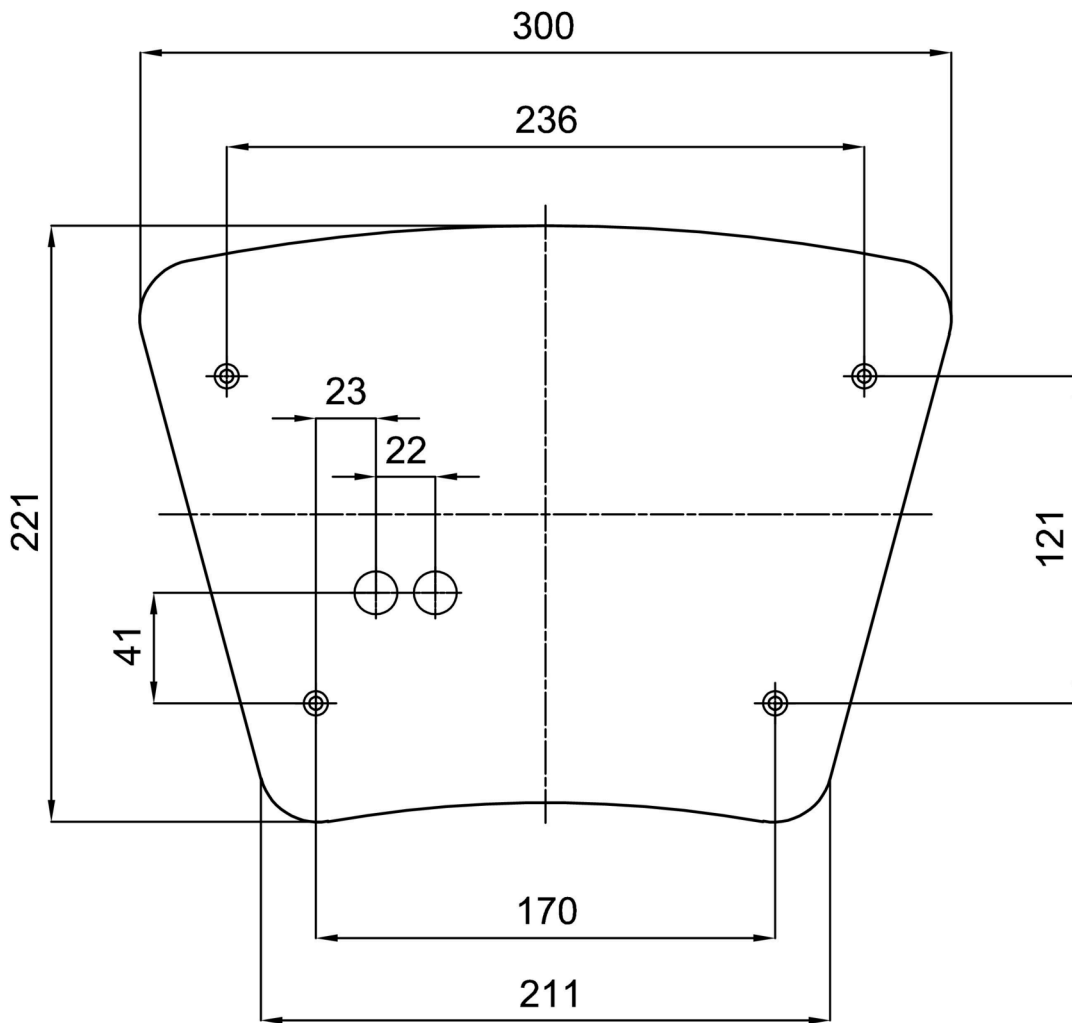

Additional assortment:

Lampshade

Product code	Name	Color	Description	Picture	Drawing
20073	421	white		