



ALKOR P2

LED-5L05E600ZKN02P/406/L100 NL 4K#

WWW.OSMONT.CZ

ALKOR P2

Product code: ALK67614

Type: LED-5L05E600ZKN02P/406/L100 NL 4K#

Short description of the luminaire: Stainless steel polished | pendant LED light ON/OFF | TRIPLEX OPAL hand blown glass shade | rod pendant 100 cm |



Technical data

| | |
|---------------------------|--------------------------------|
| Types of luminaires | Classic on/off |
| Mounting type | Suspended - rod |
| Base material | stainless steel steel |
| Shade material | three-layer glass TRIPLEX OPAL |
| Base color | polished stainless steel |
| Shade color | white |
| Holding the shade | folding system |
| Mounting location | ceiling |
| Width | 140 mm |
| Length | 140 mm |
| Height | 210 mm |
| Diameter | ø 140 mm |
| Suspension length | 1000 mm |
| mounting holes (diameter) | 3xø5mm |
| Cable entrance | 2xø16mm |
| Energy Class | D |
| Impact strength | IK01 |
| Operating temperature | from -20°C to +30°C |

Electrical data

| | |
|-------------------------------------|----------------------|
| Power consumption | 10 W |
| Ingress Protection | IP40 |
| Socket | LED modul |
| terminal block | screw terminal block |
| Automatic circuit breaker type B10A | 38 pcs |
| Automatic circuit breaker type B16A | 60 pcs |
| Automatic circuit breaker type C10A | 60 pcs |
| Automatic circuit breaker type C16A | 97 pcs |
| Number of LED drivers | 1 |

Luminous data

| | |
|-----------------------------|--------------|
| Lum. flux of luminaire | 1220 lm |
| Lum. flux of light source | 1520 lm |
| Luminaire efficacy | 122 lm/W |
| Chromaticity temperature | 4000 K |
| Rated life time LED L80/B10 | 100000 hours |
| CRI | Ra80 |
| MacAdam | 3 |
| Blue light hazard | Risk group 0 |

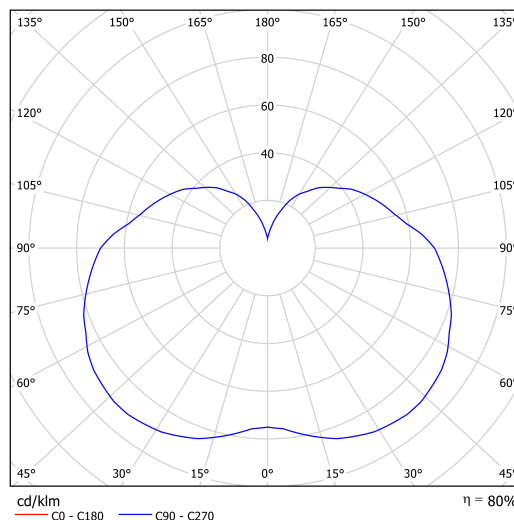

TECHNICAL SHEET



Eulum data for calculation programs are available at www.osmont.cz.

Logistical data

| | |
|-----------|---------------|
| EAN | 8591728228293 |
| Warranty* | 60 months |

*The warranty for the batteries is valid for 36 months from the date of purchase.

Installation dimensions:

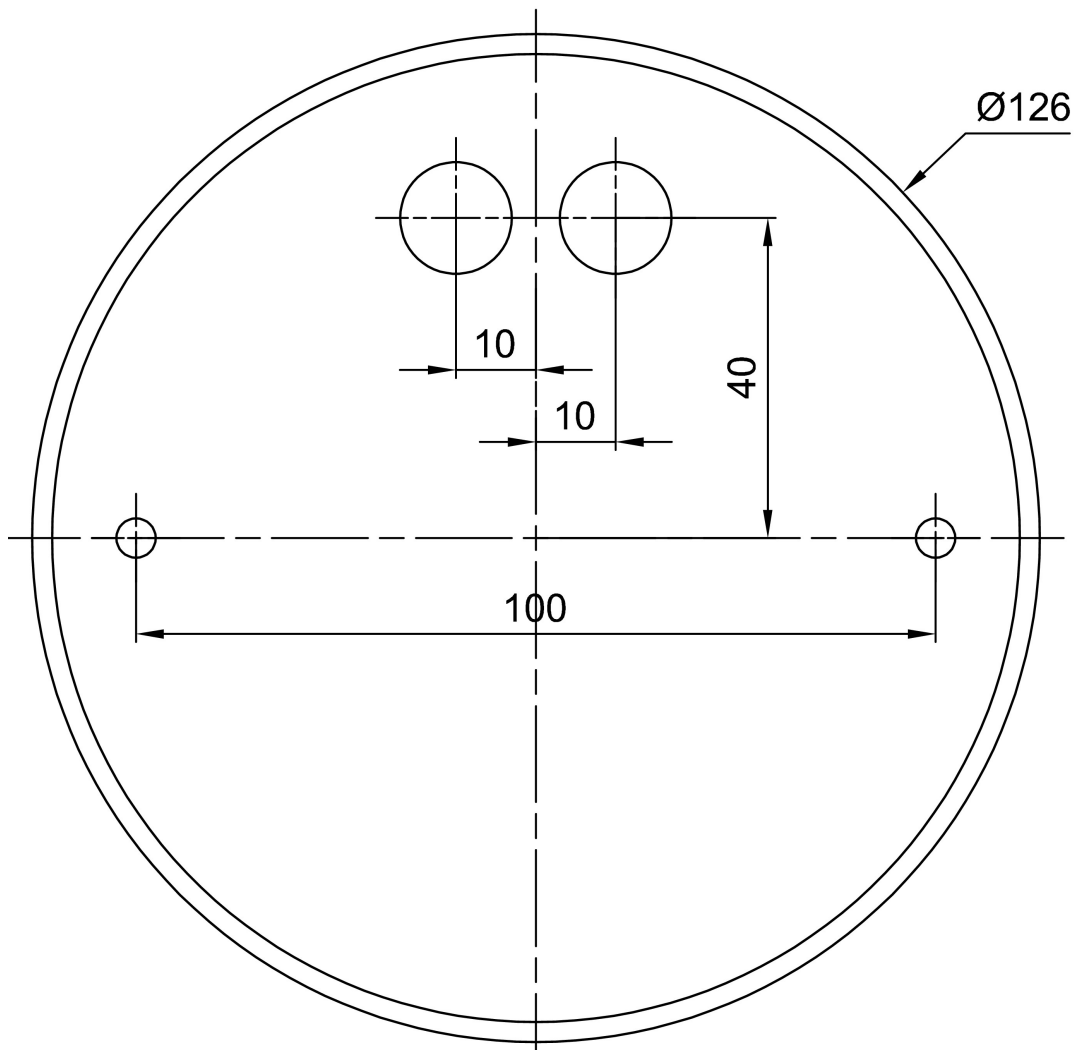

Additional assortment:

Lampshade

| Product code | Name | Color | Picture | Drawing |
|--------------|------|-------|---|---------|
| 20121 | 406 | white |  | |