



ALKOR P2

LED-5L05E600ZKN02P/406/L100 B 4K#

WWW.OSMONT.CZ

ALKOR P2

Product code: ALK67611

Type: LED-5L05E600ZKN02P/406/L100 B 4K#

Short description of the luminaire: White colour | pendant LED light ON/OFF | TRIPLEX OPAL hand blown glass shade| rod pendant 100 cm |



Technical data

Types of luminaires	Classic on/off
Mounting type	Suspended - rod
Base material	steel
Shade material	three-layer glass TRIPLEX OPAL
Base color	white Ral9003
Shade color	white
Holding the shade	folding system
Mounting location	ceiling
Width	140 mm
Length	140 mm
Height	210 mm
Diameter	ø 140 mm
Suspension length	1000 mm
mounting holes (diameter)	3xø5mm
Cable entrance	2xø16mm
Energy Class	D
Impact strength	IK01
Operating temperature	from -20°C to +30°C



Electrical data

Power consumption	10 W
Ingress Protection	IP40
Socket	LED modul
terminal block	screw terminal block
Automatic circuit breaker type B10A	38 pcs
Automatic circuit breaker type B16A	60 pcs
Automatic circuit breaker type C10A	60 pcs
Automatic circuit breaker type C16A	97 pcs
Number of LED drivers	1

Luminous data

Lum. flux of luminaire	1220 lm
Lum. flux of light source	1520 lm
Luminaire efficacy	122 lm/W
Chromaticity temperature	4000 K
Rated life time LED L80/B10	100000 hours
CRI	Ra80
MacAdam	3
Blue light hazard	Risk group 0

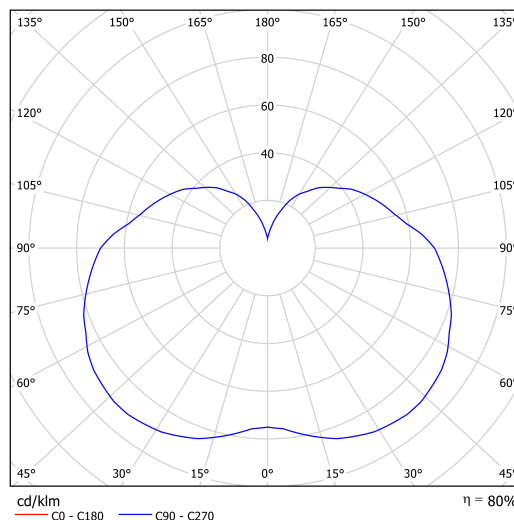

TECHNICAL SHEET



Eulum data for calculation programs are available at www.osmont.cz.

Logistical data

EAN	8591728228262
Warranty*	60 months

*The warranty for the batteries is valid for 36 months from the date of purchase.

Installation dimensions:

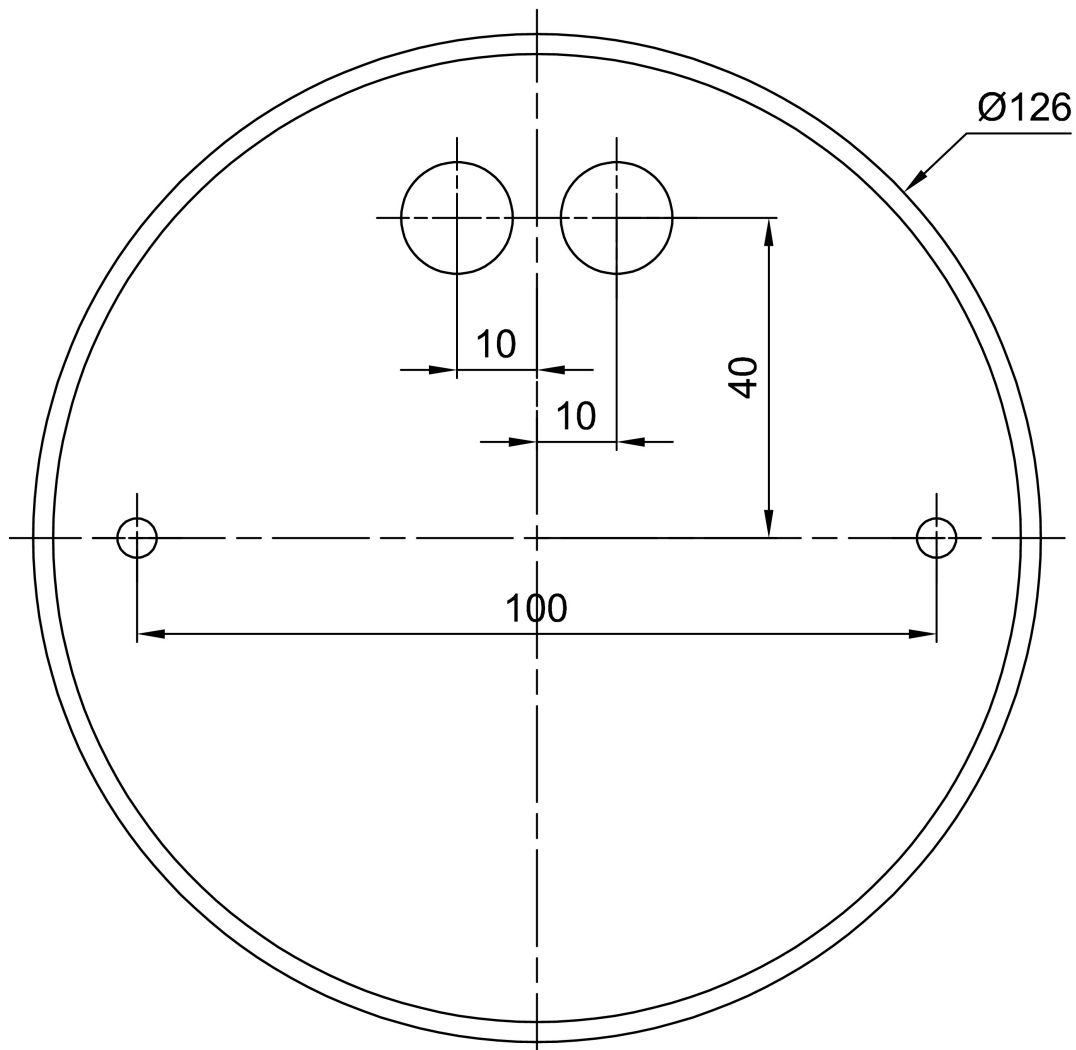

Additional assortment:

Lampshade

Product code	Name	Color	Picture	Drawing
20121	406	white	