



ADRIA P2 HP

LED-5L06E700Z11/094/L60 NB DALI 3K#

WWW.OSMONT.CZ

ADRIA P2 HP

Product code: ADR50117

Type: LED-5L06E700Z11/094/L60 NB DALI 3K#

Short description of the luminaire: Stainless steel brushed | pendant high-power LED light DALI | TRIPLEX OPAL hand blown glass shade | rod pendant 60 cm |



Technical data

Types of luminaires	Dimmable
Mounting type	Suspended - rod
Base material	stainless steel steel
Shade material	three-layer glass TRIPLEX OPAL
Base color	brushed stainless steel
Shade color	white
Holding the shade	steel holder
Mounting location	ceiling
Width	300 mm
Length	300 mm
Height	300 mm
Diameter	ø 300 mm
Suspension length	600 mm
mounting holes (diameter)	none
Energy Class	D
Impact strength	IK01
Operating temperature	from -20°C to +30°C

Electrical data

Power consumption	33 W
Ingress Protection	IP40
Socket	LED modul
terminal block	none

Luminous data

Lum. flux of luminaire	4400 lm
Lum. flux of light source	5000 lm
Chromaticity temperature	3000 K
Rated life time LED L80/B10	100000 hours
CRI	Ra80
MacAdam	3
Blue light hazard	Risk group 0

Eulum data for calculation programs are available at www.osmont.cz.

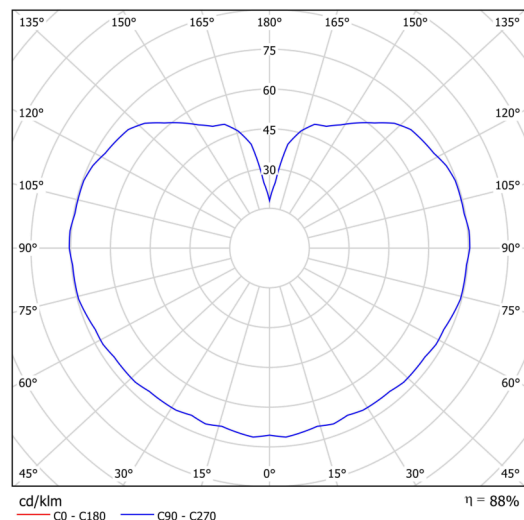
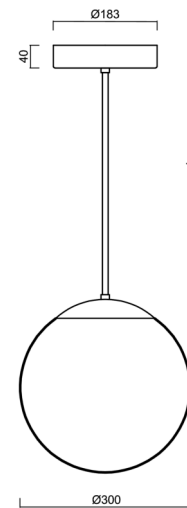

TECHNICAL SHEET



Logistical data

EAN	8591728196837
Warranty*	60 months

*The warranty for the batteries is valid for 36 months from the date of purchase.

Installation dimensions:

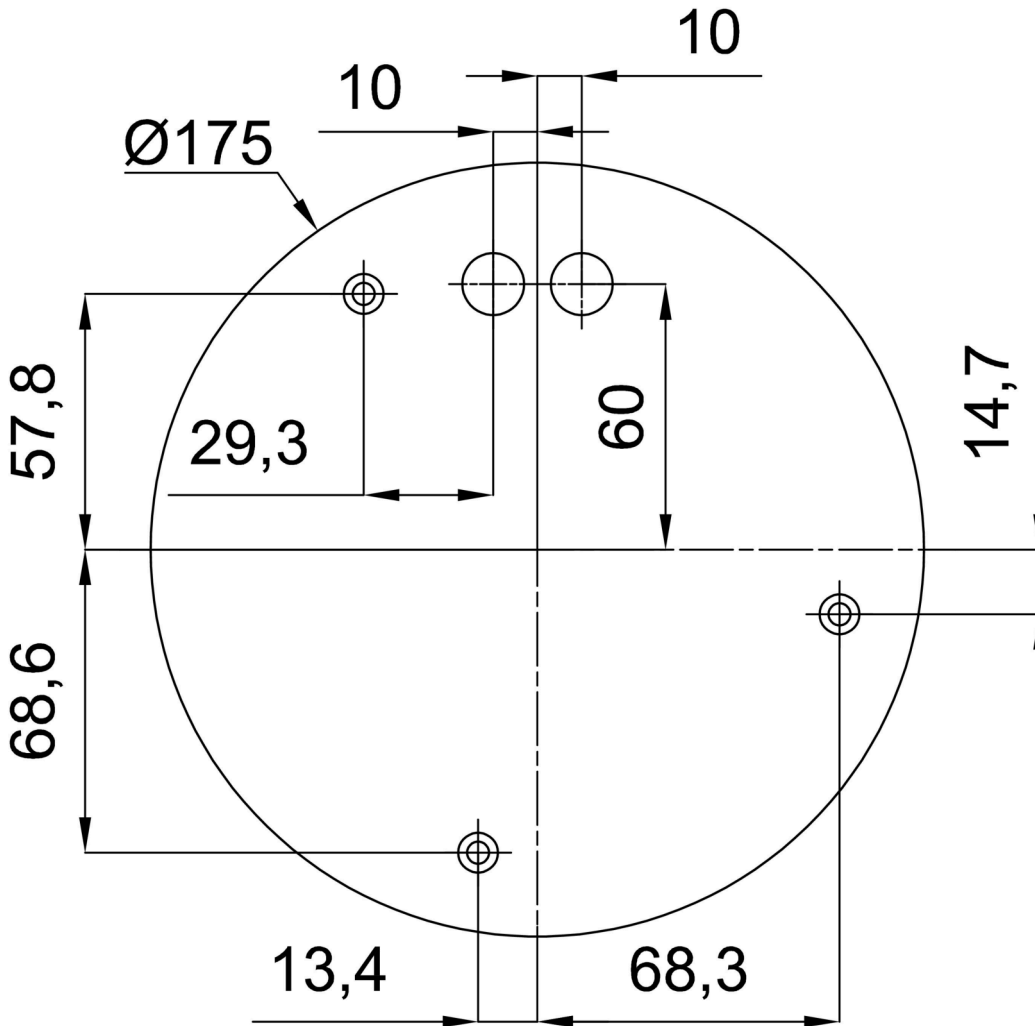

Additional assortment:

Lampshade

Product code	Name	Color	Picture	Drawing
20039	094	white	