



ADRIA L3A HP

LED-5L06E900ZL11/097/L100 NK3HST C 3K#

WWW.OSMONT.CZ

ADRIA L3A HP

Product code: ADR50366

Type: LED-5L06E900ZL11/097/L100 NK3HST C 3K#

Short description of the luminaire: Black colour | pendant LED light with emergency backup combined (with Self-test) | TRIPLEX OPAL hand blown glass shade| steel wire pendant (with supply cable) 100 cm |

Technical data

Types of luminaires	Emergency combined SELFTEST
Mounting type	Suspended - wire
Base material	steel
Shade material	three-layer glass TRIPLEX OPAL
Base color	black Ral9005
Shade color	white
Holding the shade	steel holder
Mounting location	ceiling
Width	350 mm
Length	350 mm
Height	350 mm
Diameter	ø 350 mm
Suspension length	1000 mm
mounting holes (diameter)	none
Energy Class	D
Impact strength	IK01
Operating temperature	from +5°C to +30°C

Electrical data

Power consumption	43 W
Ingress Protection	IP40
Socket	LED modul
Battery type	LiFePO4
Emergency time	3 hours
SELFTEST	yes
terminal block	none
Automatic circuit breaker type B10A	7 pcs
Automatic circuit breaker type B16A	12 pcs
Automatic circuit breaker type C10A	13 pcs
Automatic circuit breaker type C16A	21 pcs
Number of LED drivers	1

Luminous data

Lum. flux of luminaire	5630 lm
Lum. flux of light source	6400 lm
Lum. flux of light source in emergency mode	200 lm
Luminaire efficacy	130 lm/W

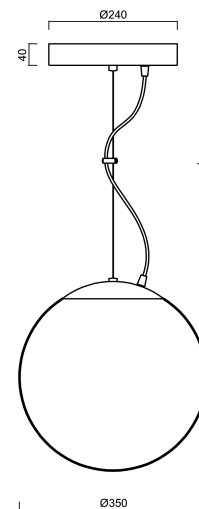

TECHNICAL SHEET

Chromaticity temperature	3000 K
Rated life time LED L80/B10	100000 hours
CRI	Ra80
MacAdam	3
Blue light hazard	Risk group 0

Eulum data for calculation programs are available at www.osmont.cz.

Logistical data

EAN	8591728199326
Warranty*	60 months

*The warranty for the batteries is valid for 36 months from the date of purchase.

Installation dimensions:

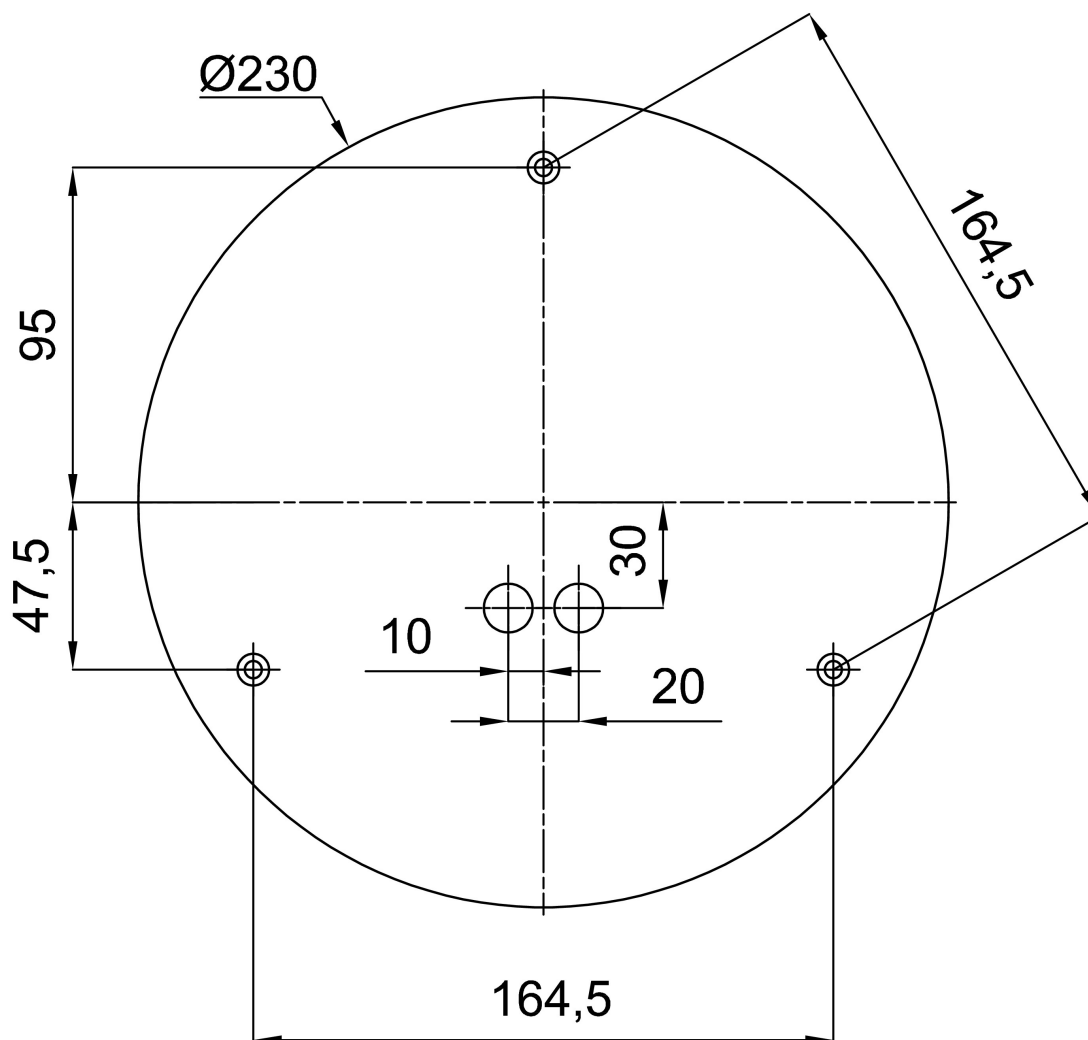

Additional assortment:

Lampshade

Product code	Name	Color	Picture	Drawing
20144	097	white		