



ADRIA L2 HP

LED-5L06E700ZL11/094/L100 NL 4K#

WWW.OSMONT.CZ

ADRIA L2 HP

Product code: ADR50626

Type: LED-5L06E700ZL11/094/L100 NL 4K#

Short description of the luminaire: Stainless steel polished | pendant high-power LED light ON/OFF | TRIPLEX OPAL hand blown glass shade| steel wire pendant (with supply cable) 100 cm |

Technical data

Types of luminaires	Classic on/off
Mounting type	Suspended - wire
Base material	stainless steel steel
Shade material	three-layer glass TRIPLEX OPAL
Base color	polished stainless steel
Shade color	white
Holding the shade	steel holder
Mounting location	ceiling
Width	300 mm
Length	300 mm
Height	300 mm
Diameter	ø 300 mm
Suspension length	1000 mm
mounting holes (diameter)	none
Energy Class	D
Impact strength	IK01
Operating temperature	from -20°C to +30°C

Electrical data

Power consumption	33 W
Ingress Protection	IP40
Socket	LED modul
terminal block	none
Automatic circuit breaker type B10A	31 pcs
Automatic circuit breaker type B16A	50 pcs
Automatic circuit breaker type C10A	52 pcs
Automatic circuit breaker type C16A	85 pcs
Number of LED drivers	1

Luminous data

Lum. flux of luminaire	4590 lm
Lum. flux of light source	5220 lm
Luminaire efficacy	139 lm/W
Chromaticity temperature	4000 K
Rated life time LED L80/B10	100000 hours
CRI	Ra80
MacAdam	3
Blue light hazard	Risk group 0

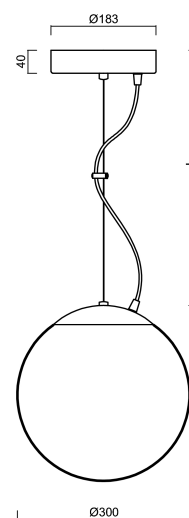
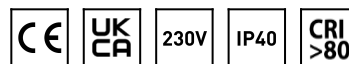

TECHNICAL SHEET



Eulum data for calculation programs are available at www.osmont.cz.

Logistical data

EAN	8591728203177
Warranty*	60 months

*The warranty for the batteries is valid for 36 months from the date of purchase.

Installation dimensions:

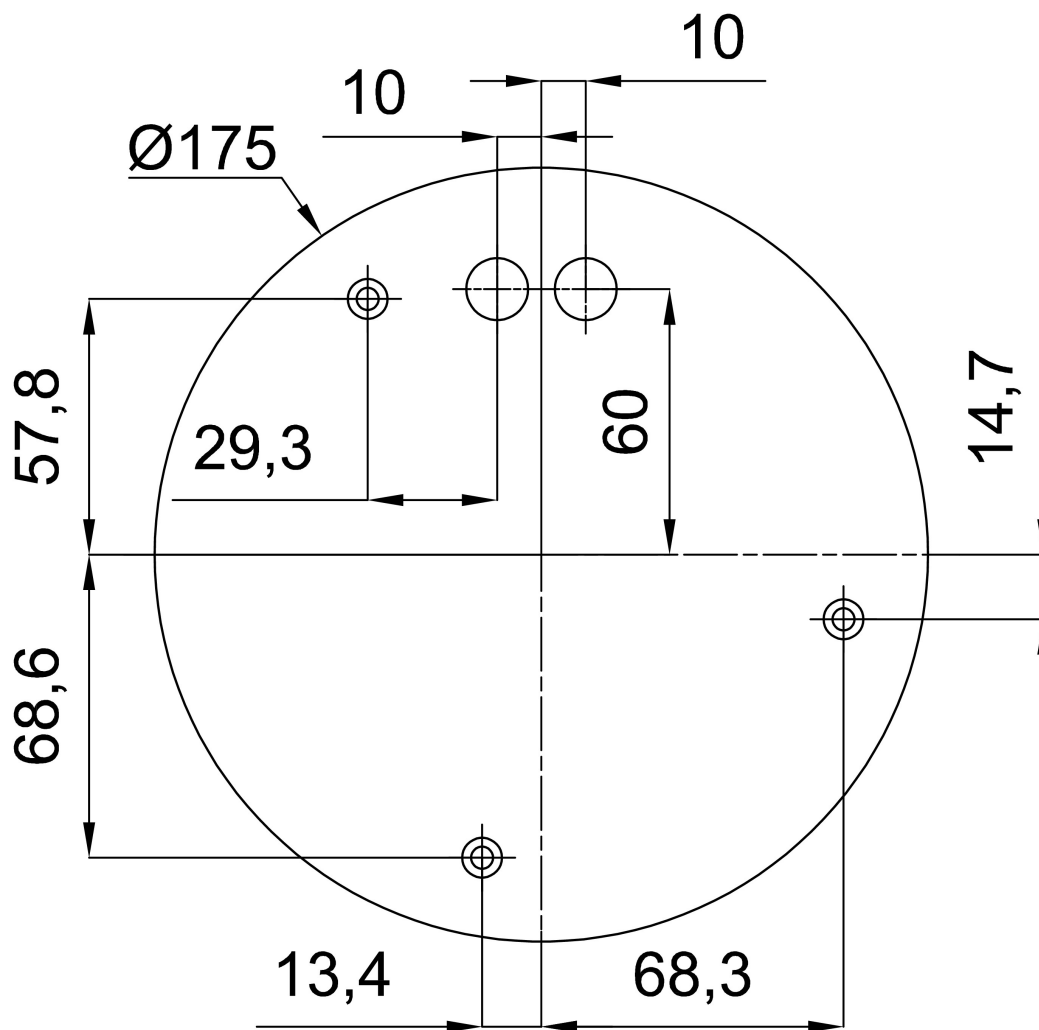

Additional assortment:

Lampshade

Product code	Name	Color	Picture	Drawing
20039	094	white		